

SINGLE PHASE FULL WAVE DIRECT PWM MOTOR DRIVER

NEW PRODUCT

Description

The AM4964 is highly integrated feature rich single phase Brushless Direct Current (BLDC) full wave motor driver with combined PWM and temperature speed control function for fans, blowers and extractors.

For system flexibility, the motor speed can be controlled by an external PWM signal and temperature sensed by Thermal resistor at the same time. Based on external input PWM and temperature signals, the AM4964 adjusts the output PWM duty cycle. If the input PWM duty is constant, the output PWM duty varies with temperature sensed by Thermal resistor sensor between the low and high temperature corners. If the temperature signal is constant, the output duty varies with the external input PWM duty. The low and high temperature corners and the output PWM duty gap between these temperature corners are adjustable

To help protect the motor coil, the AM4964 provides a rotor lock protection which shuts down the output if rotor lock is detected. The device automatically re-starts when the rotor lock is removed.

AM4964 provides a tachometer output Frequency Generator (FG). The FG output is the magnetic change frequency.

The AM4964 is available in TSSOP-20EP package.

Pin Assignments

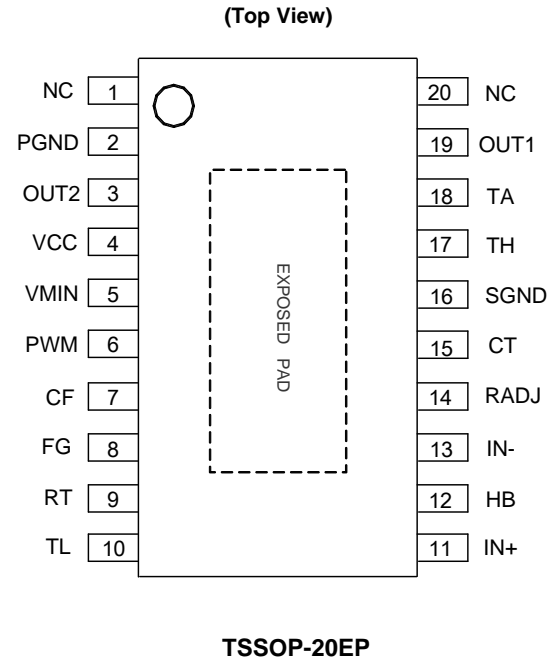

Features

- Flexible Speed Control Options
 - Combined PWM+Thermistor Speed Control
 - PWM Speed Control
 - DC Voltage Speed Control
- Adjustable Low and High Temperature Corners
- Full Speed When Thermal Resistor is Shorted
- Adjustable Output Duty Gap between High and Low Temperature when 100% PWM Input
- Built-in oscillator – No external capacitor
- Built-in Minimal Speed Setup Circuit
- Alpha Slope Adjustable
- Rotation Speed Indicator (FG)
- Built-in Temperature Control Circuit
- Built-in Thermal Shutdown Circuit
- Lock Protection and Auto-restart
- **Totally Lead-free & Fully RoHS Compliant (Notes 1 & 2)**
- **Halogen and Antimony Free. "Green" Device (Note 3)**

Applications

- CPU Cooler Fan in PC
- Brushless DC Motor Driver

Notes: 1. No purposely added lead. Fully EU Directive 2002/95/EC (RoHS) & 2011/65/EU (RoHS 2) compliant.
 2. See http://www.diodes.com/quality/lead_free.html for more information about Diodes Incorporated's definitions of Halogen- and Antimony-free, "Green" and Lead-free.
 3. Halogen- and Antimony-free "Green" products are defined as those which contain <900ppm bromine, <900ppm chlorine (<1500ppm total Br + Cl) and <1000ppm antimony compounds.

Typical Applications Circuit

NEW PRODUCT

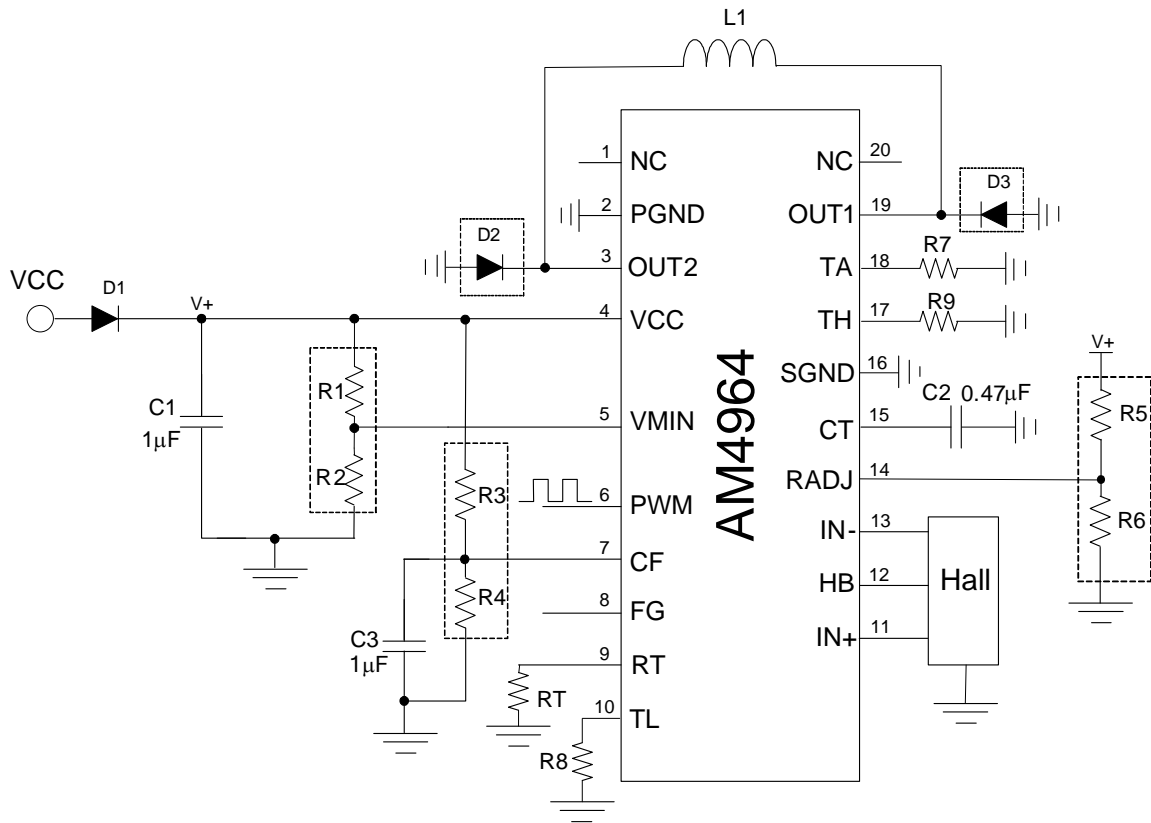

Pin Descriptions

Pin Number	Pin Name	Function
1,20	NC	Not connected
2	PGND	Power ground
3	OUT2	Fan driver output2
4	VCC	Power supply
5	VMIN	Minimum speed setting pin
6	PWM	PWM pulse input terminal
7	CF	Filter capacitor
8	FG	FG signal output
9	RT	RT signal output
10	TL	Low temperature set resistor
11	IN+	Hall sensor input+
12	HB	Hall bias voltage
13	IN-	Hall sensor input-
14	RADJ	Output pulse duty/input pulse duty adjustable terminal
15	CT	Lock protect and auto start
16	SGND	Signal ground
17	TH	High temperature set resistor
18	TA	Output duty gap adjust pin between low and high temperature at 100% input duty
19	OUT1	Fan driver output1
	Exposed pad	Central exposed pad – The central exposed pad is for thermal dissipation. On PCB layout, the exposed pad can be connected to GND or remain unconnected to any other signals

Functional Block Diagram

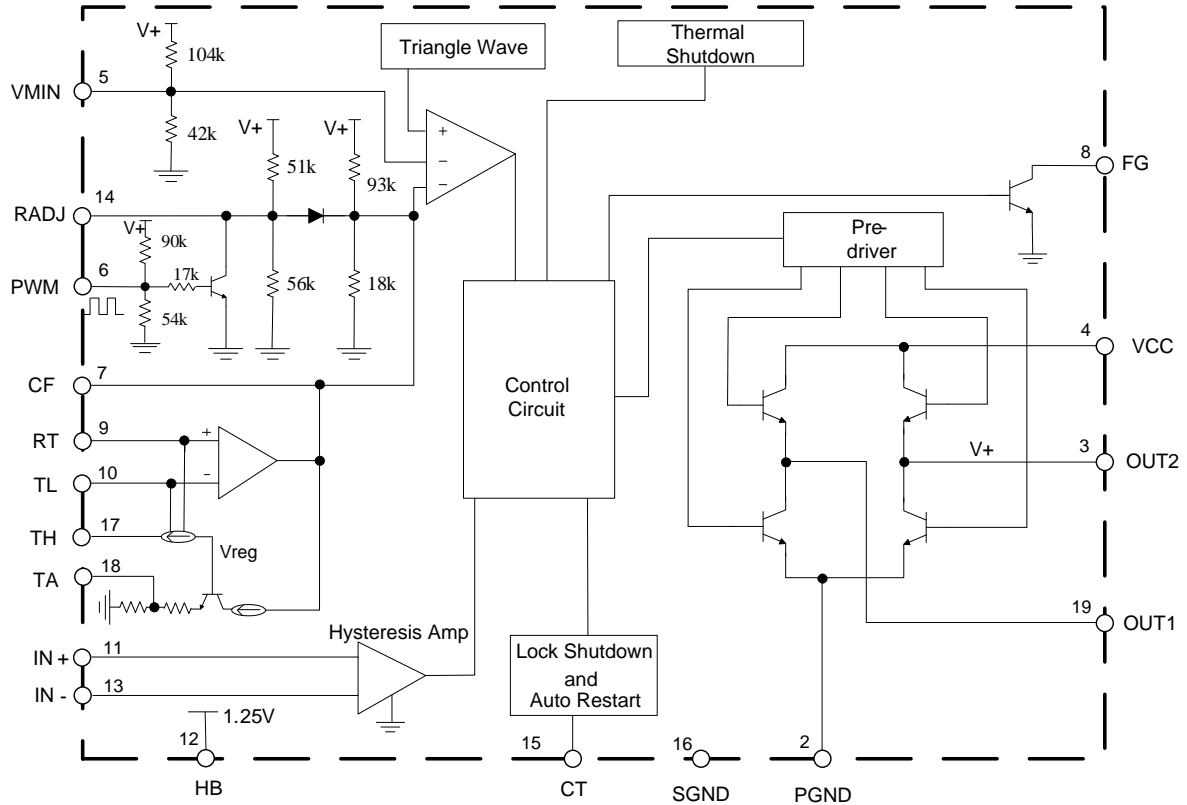

Truth Table

Items	IN-	IN+	CF	CT	OUT1	OUT2	FG	Mode
1	H	L	L	L	H	L	L	Rotation
2	L	H			L	H	Off	Off
3	H	L	H		Off	L	L	Rotation Recirculation
4	L	H			L	Off	Off	Off
5	H	L	L	H	H	Off	L	Lock Protection
6	L	H			Off	H	Off	

NEW PRODUCT

Absolute Maximum Ratings (Note 4) (@T_A = +25°C, unless otherwise specified.)

Symbol	Parameter	Rating	Unit
V _{CC}	Supply Voltage	18	V
I _{OUT}	Output Current	1.0	A
V _{OUT}	Output Voltage	18	V
V _{FG}	FG Output Voltage	18	V
I _{FG}	FG Output Current	10	mA
P _D	Power Dissipation	1.1	W
T _{STG}	Storage Temperature Range	-55 to +150	°C
θ _{JA}	Thermal Resistance (Junction to Ambient) (Note 5)	114	°C/W
ESD	ESD (Human Body Model)	3000	V
ESD	ESD (Machine Model)	300	V

- Notes:
- Stresses greater than those listed under “Absolute Maximum Ratings” may cause permanent damage to the device. These are stress ratings only, and functional operation of the device at these or any other conditions beyond those indicated under “Recommended Operating Conditions” is not implied. Exposure to “Absolute Maximum Ratings” for extended periods may affect device reliability
 - TSSOP-20EP exposed pad is soldered to minimum recommended landing pads (see Package Outline Dimension section) on a 4.0mm x 3.0mm two-layer 2oz.copper FR4 PCB (1.6mm thickness) with four thermal vias in the exposed PAD to the copper flood on the bottom layer. See thermal de-rating curves in the thermal performance section.

Recommended Operating Conditions

Symbol	Parameter	Min	Typ	Max	Unit
V _{CC}	Supply Voltage	3.5	12	16	V
V _{IN+}	Hall Input Voltage +	0.2	–	3	V
V _{IN-}	Hall Input Voltage -	0.2	–	3	V
T _A	Ambient Temperature	-30	–	+90	°C

Electrical Characteristics (@V_{CC}=12V, T_A=+25°C, unless otherwise specified.)

Symbol	Parameter	Conditions	Min	Typ	Max	Unit
I _{Q1}	Quiescent Current	V _{CT} =L	10.15	15	18.75	mA
I _{Q2}		V _{CT} =H	5.35	8	10.5	
V _{SATH}	Output Saturation Voltage at High Side	I _{SOURCE} =200mA	–	1.0	1.17	V
V _{SATL}	Output Saturation Voltage at Low Side	I _{SINK} =200mA	–	0.2	0.3	V
f _{PWM}	CPWM Frequency	–	18	25	32	kHz
V _{CPWMH}	CPWM High Level Voltage	–	3.40	–	3.8	V
V _{CPWML}	CPWM Low Level Voltage	–	1.8	–	2.3	V
V _{CFH1}	CF High Level Voltage	–	2.95	–	3.35	V
V _{CFH2}		–	2.95	–	3.45	
V _{CFL1}	CF Low Level Voltage	–	2.35	–	2.85	V
V _{CFL2}		–	1.75	–	2.25	
V _{ADJ1}	RADJ Pin Voltage	–	3.65	–	4.15	V
V _{ADJ2}		–	3.75	–	4.25	
V _{MIN}	VMIN Voltage	–	2.48	–	3.22	V
V _{HB}	Bias	–	1	–	1.5	V
V _{HYS}	Hall Input Hysteresis	–	–	±10	±20	mV
V _{CTH}	CT High Level Voltage	–	3.55	3.7	3.88	V
V _{CTL}	CT Low Level Voltage	–	1.55	1.7	1.85	V
I _{CHG}	CT Charge Current	–	1.15	2	3.55	μA
I _{DHG}	CT Discharge Current	–	0.115	0.2	0.355	μA
R _{CD}	CT Charge and Discharge Ratio	I _{CHG} /I _{DHG}	8.5	10	14.5	–
V _{FGL}	FG Output Low Level Voltage	I _{FG} =5mA	–	0.2	0.3	V
I _{LFG}	FG Leakage Current	V _{FG} =7V	–	–	30	μA

Functional Descriptions

HB – Hall Bias Output

This is a 1.25V nominal voltage source to bias a differential un-buffered Hall element sensor. If a Hall element requires a lower voltage than the H-Bias output, connect an appropriate value resistor between the HB pin and the Hall element supply pin.

IN+ and IN- – Hall Inputs

The rotor position is detected by a Hall sensor, with the output applied to the IN+ and IN- pins. This sensor can be either a 4 pin 'naked' Hall device or of the 3-pin buffered switching type. For a 4-pin device the differential Hall output signal is connected to the IN+ and IN-pins. For a buffered Hall sensor the Hall device output is attached to the IN+ pin, with a pull-up attached if needed, whilst the IN- pin has an external potential divider attached to hold the pin at half V_{REF} . When IN+ is high in relation to IN-, OUT2 is the active drive.

PWM – Pulse Width Modulate Signal Input Pin

The PWM signal is applied at this pin and then be translated to be stable voltage to control the motors rotate speed.

TL – Low Temperature Corner Set Pin

A resistor (R8) is connected between TL and ground to adjust the low corner temperature.

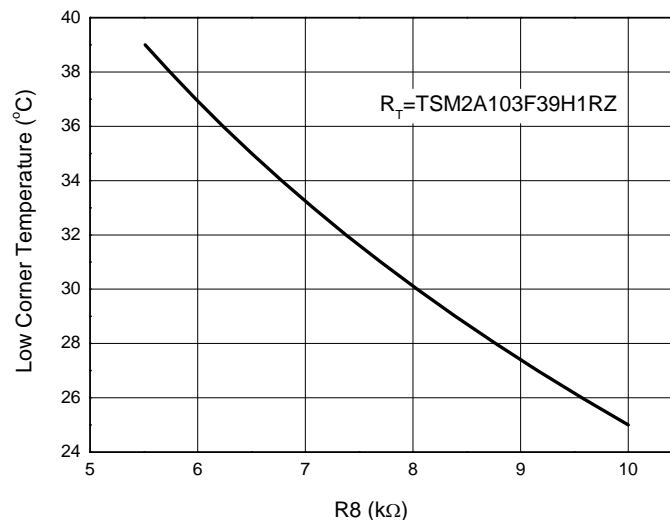

Low Temperature Corner Value vs. R8 Resistor Value

Functional Descriptions (cont.)

TH – High Temperature Corner Set Pin

A resistor (R9) is connected between TH and ground to adjust the high corner temperature. High corner temperature can be estimated by: $T_H = T_L + 5 \cdot R_9 / 100$.

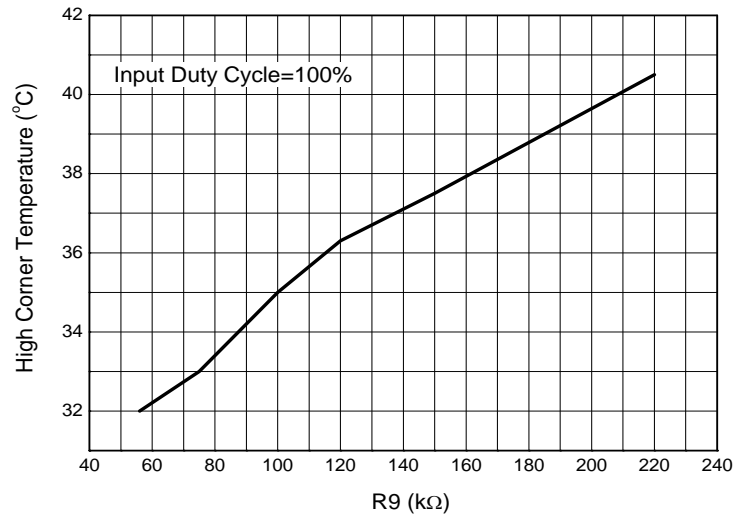

High Temperature Corner vs. R9

TA – Output Duty Gap Adjust between High and Low Temperature Corners When Input Duty is 100%

A resistor (R7) is connected between TA and ground to adjust the output PWM duty gap between high temperature and low temperature corners when the external input PWM duty is 100%.

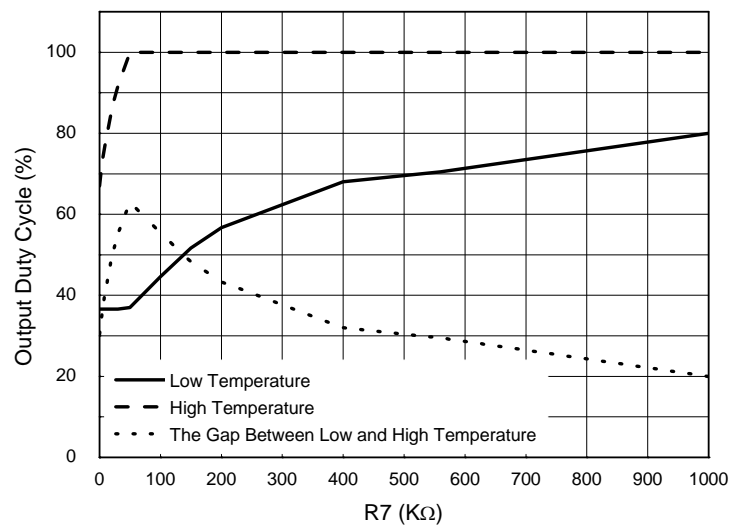

Output PWM Duty vs. R7

Functional Descriptions (cont.)

CF –CF Capacitor Pin

A capacitor is connected to this pin as a filter to translate PWM signal to be stable voltage. The resistors R3 and R4 are connected to CF pin to adjust the maximum speed at high temperature and low temperature corners.

Adjust the maximum speed vs. input duty to approximately match the target specification using R3 and R4 at low temperature ($T < T_L$, $V_8 < V_7$); Measure the fan rotating speed vs. input duty. And draw a curve figure accordingly (Step=5%).

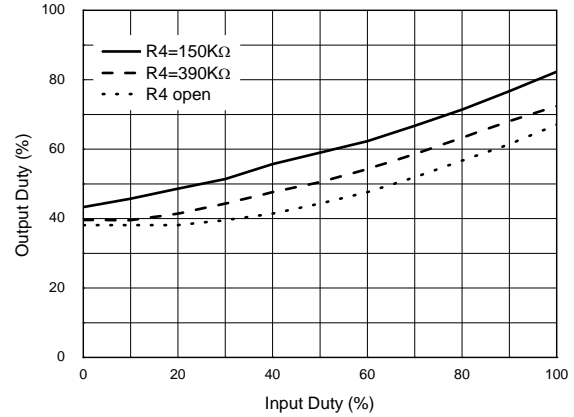
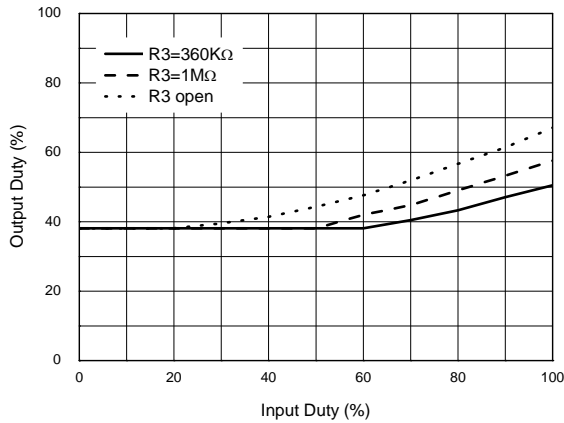

Output PWM Duty vs. R3 and R4 at Low Temperature

Adjust the maximum speed vs. input PWM duty to approximately match the target specification using R3 and R4 at high temperature ($T > T_H$, $V_8 > V_7 + 0.7V$).

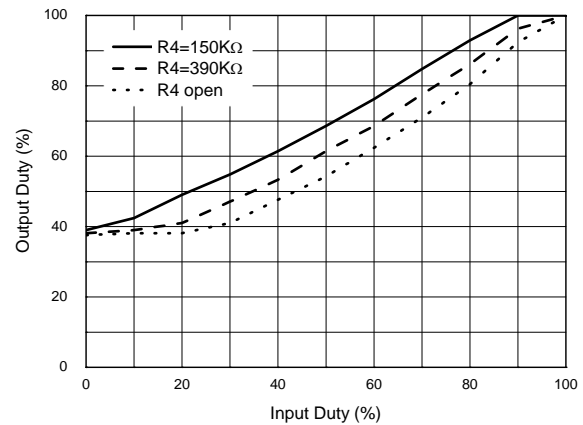
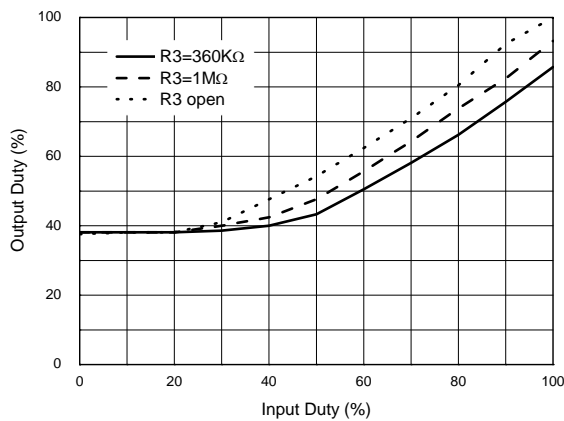

Output PWM Duty vs. R3 and R4 at High Temperature

Functional Descriptions (cont.)

RADJ – Adjust the Line Slope of the Input PWM Duty vs. Output PWM Duty at the OUT1 and OUT2

Adjust Slope K of the fan rotating speed (or output duty) vs. input duty to approximately match the target specification using R5 and R6.

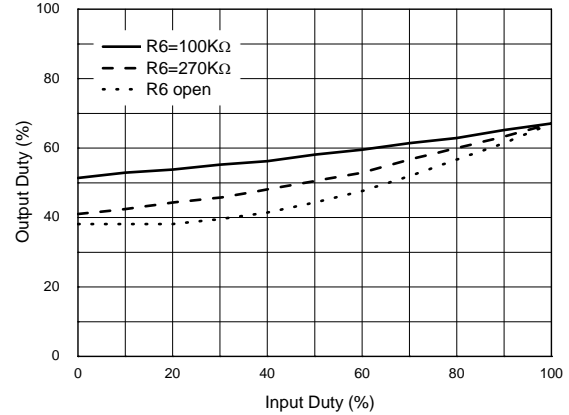
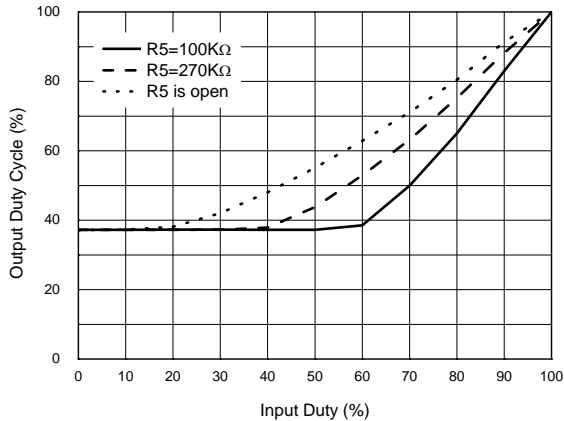

Output PWM Duty Slope K vs. Input PWM Duty with Slope K R5 and R6

VMIN – Minimum Speed Setting

A voltage can be set on this pin via a potential divider between the VREF (or Supply) and GND pins. This voltage is monitored by the PWM pin to clamp the PWM control voltage so that it does not rise above VMIN voltage. As a higher voltage on the PWM pin represents a lower speed, the VMIN setting prevents the motor speed going lower than the minimum speed set by the VMIN pin. When the VMIN voltage is higher than the lowest speed setting voltage allowed (The lowest speed voltage is about $0.28V_{CC}$), the fan speed is maintained at the lowest speed.

Adjust the minimum speed vs. input duty to approximately match the target specification via R2 (R1=15kΩ). Measure the fan rotating speed and the input duty, as shown below.

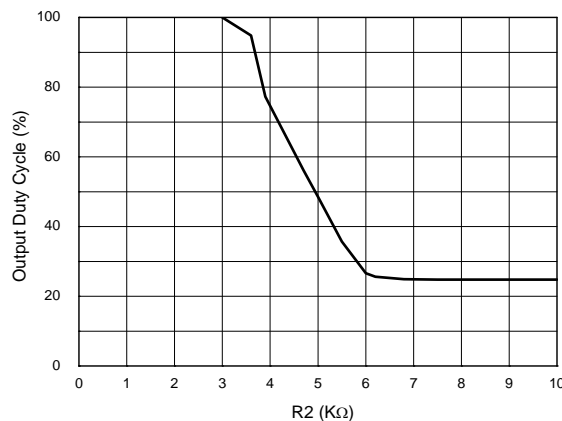

Output PWM Duty vs. R2

Functional Descriptions (cont.)

CT – Locked Rotor Timing Capacitor

The CT pin will have a capacitor connected to ground. It is a multi-function pin providing timing for the lock detect and auto-restart. Different rates of charge and discharge of CT capacitor depending on the mode of operation (fan operation status) give the lock-detect time (t_{LCKDET}) and lock time (t_{OFF}) before the next auto-start retry. When the motor is running, the capacitor is discharged at every Hall signal change.

CT pin provides the timing for the Locked Rotor monitor. In normal operation, Lock Detect is enabled. If the Hall signal does not change (i.e. a rotor lock condition) within the Lock Detect time (t_{LCKDET}), the outputs are disabled. In this condition the motor will not be driven for a set time t_{OFF} . This t_{OFF} time depends on the external CT capacitor value and its internal discharge current (I_{DHG}). After the t_{OFF} period device enters auto-restart phase to re-start the motor with a new Lock Detect time. If the motor has not turned to generate a transition on the Hall inputs by the end of this t_{LCKDET} period, the motor re-enters motor lock t_{OFF} period with the outputs disabled. If the Hall signal change is detected, the motor is deemed as running and goes into lock-detection mode. The t_{LCKDET} and t_{OFF} are determined by the value of the external capacitor on the CT pin and the internal charge and discharge currents during these time periods. The currents during t_{LCKDET} and t_{OFF} are I_{CHG} , and I_{DHG} respectively.

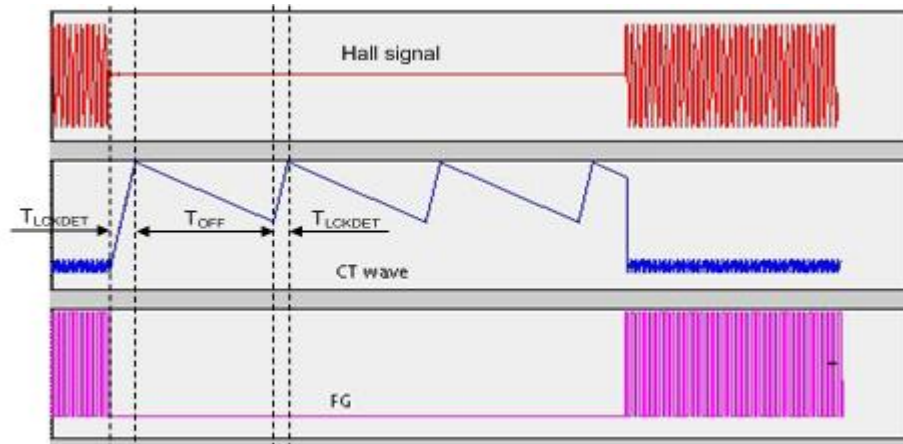

FG – Frequency Generator (Tachometer) Output Pin

This is the Frequency Generator output and is a buffered signal from the Hall sensor. This is an open collector drive giving an active pull down with the high level being provided by an external pull up resistor.

OUT1 and OUT2 Pins

OUT1 and OUT2 pins provide H bridge driver output for fan and motor coil connection.

VCC – IC Supply voltage

This pin provides the supply for the device.

GND – Supply Return

This is the device supply ground return pin for control signal.

PGND –Power Supply Return

This is the device supply ground return pin for power output pins OUT1 and OUT2 and will generally be the most negative supply pin to the fan.

Performance Characteristics

NEW PRODUCT

Quiescent Current vs. Supply Voltage

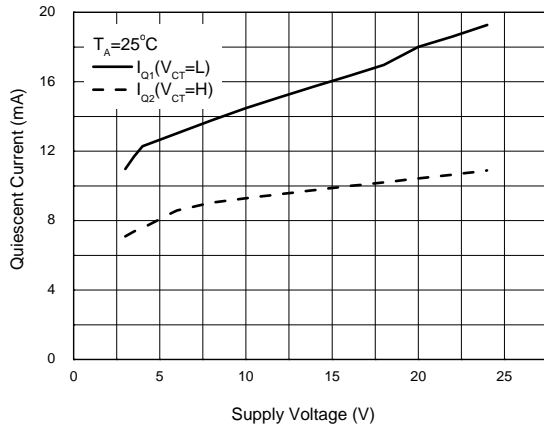

Quiescent Current vs. Ambient Temperature

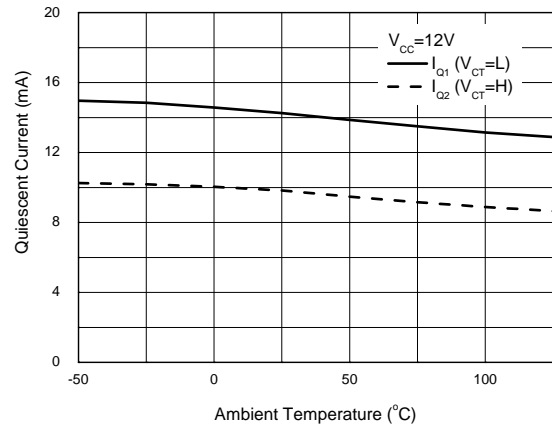

Output Saturation Voltage vs. Output Current

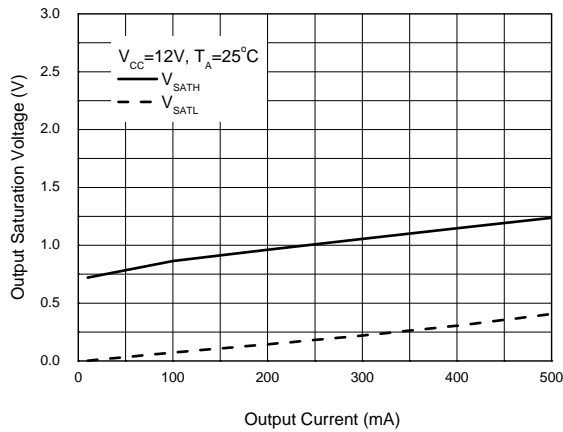

Allowable Power Dissipation vs. Allowable Temperature (Note 6)

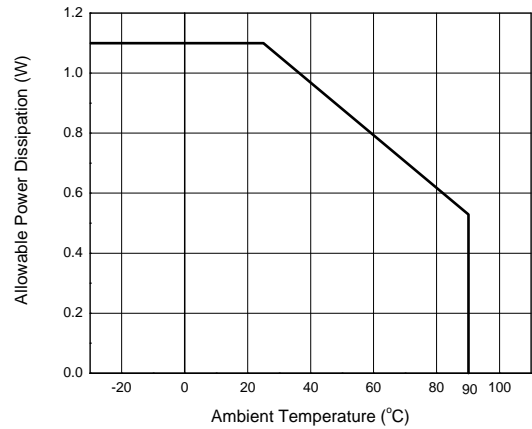

Note 6: TSSOP-20EP exposed pad is soldered to minimum recommended landing pads (see Package Outline Dimension section) on a 4.0mmx3.0mm two-layer 2oz.copper FR4 PCB (1.6mm thickness) with four thermal vias in the exposed PAD to the copper flood on the bottom layer.

Applications Note

Typical application circuit for PWM input signal for speed control with AM4964 is shown below. The speed is primarily controlled by a voltage on the CF pin (either from DC voltage signal or PWM inputs signal converted to DC voltage).

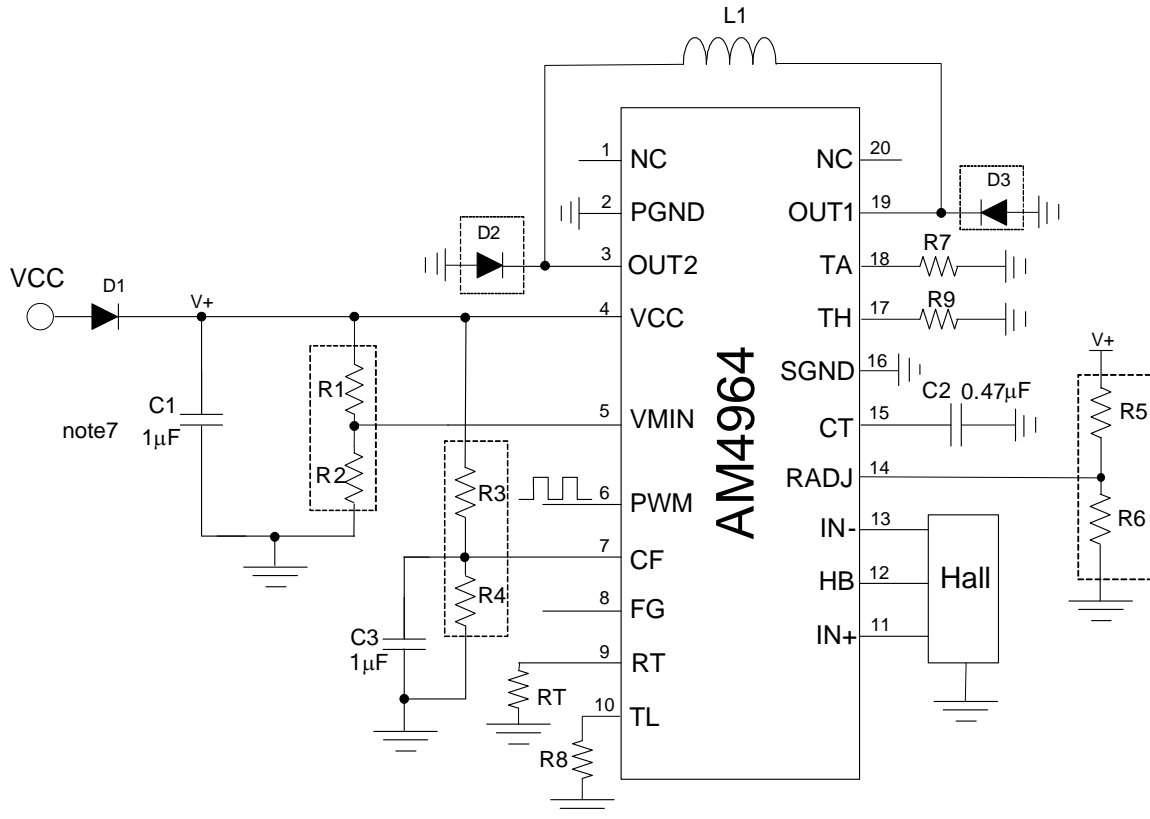

Typical Application Circuit (External PWM Input Speed Control)

Note 7: C1 is for power stabilization and should be 1µF or higher depending on the motor current and motor design.

Applications Note (cont.)

Some of typical application performance curves based on circuits above are shown below (R1 to R6 open, R8=8kΩ, R9=150kΩ).

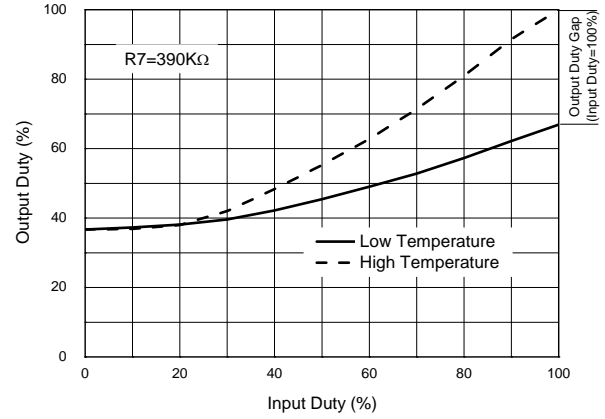
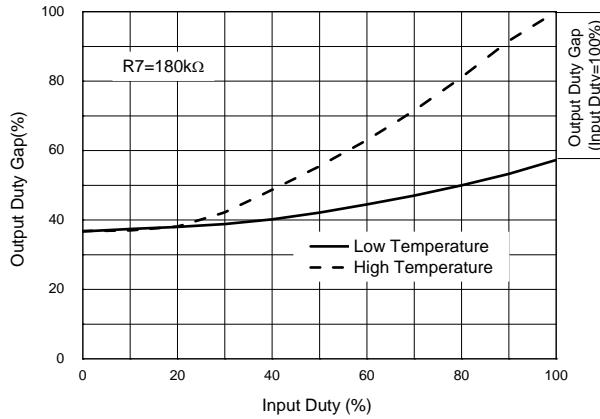

Output PWM Duty vs. Input PWM Duty with R7 (180kΩ)

Output PWM Duty vs. Input PWM Duty with R7 (390kΩ)

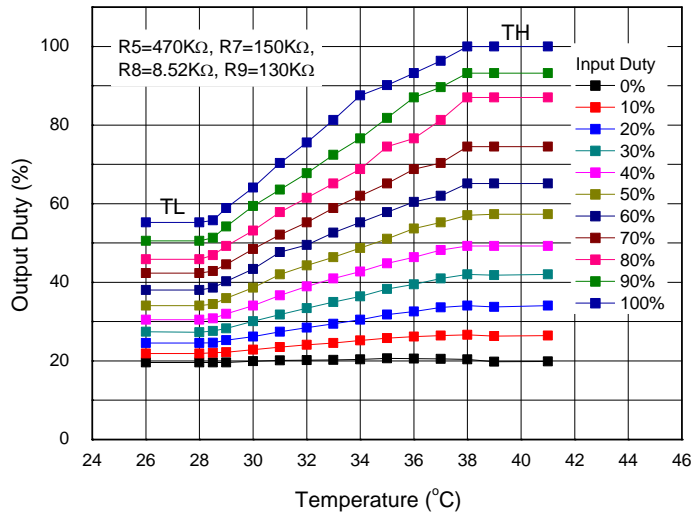

Output PWM Duty vs. Temperature

NEW PRODUCT

Applications Note (cont.)

Power Supply Stabilization

The recommended operating voltage range for AM4964 is 3.5V to 16V. A decoupling capacitor C1 (which also acts as re-circulating capacitor at commutation) should be connected close to the VCC pin. C1 is for power stabilization and should be 1 μ F or higher depending on the motor current and motor design.

Hall Bias and Hall Input for Commutation Signal

The HB pin provides a 1.25V Hall bias voltage to drive Hall element. The output of the Hall elements or the Hall switches is connected to Hall input IN+ and IN- pin as described previously in functional description section. To avoid noise, the connection to the Hall element or switch should be as short as possible. The Hall input stage (IN+ and IN- pin) has a hysteresis of 20mV typical. The differential Hall input signal should be 50mV peak or higher.

Speed Control

The motor speed is governed by the output PWM duty of the H Bridge.

Speed Control

The motor speed is governed by the output PWM duty of the H Bridge.

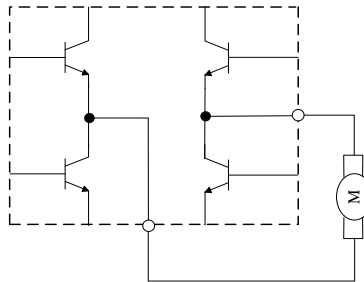

The voltage on the CF, VMIN pin and the internal triangle wave voltage controls the output PWM duty and therefore the speed of the motor. When the CF voltage is smaller than VMIN voltage, the output PWM duty is generated by comparing the triangular voltage with CF. If the CF pin voltage is higher than the VMIN pin, the speed is controlled by comparing the triangular voltage with VMIN voltage. When the PWM voltage is lower than the low side of the triangular voltage, the motor will run at full speed. See "Speed Control and Minimum Speed Setting" figure.

An input DC voltage from 3.6V to 1.9V (for 12V supply) on the CF pin controls the output PWM duty from 0% to 100% thus allowing speed control from 0% to 100% of the full speed. The DC voltage of CF can be adjusted by PWM input signal duty and the ambient temperature sensed by the thermistor (resistive sensor) connected to RT pin.

Applications Note (cont.)

NEW PRODUCT

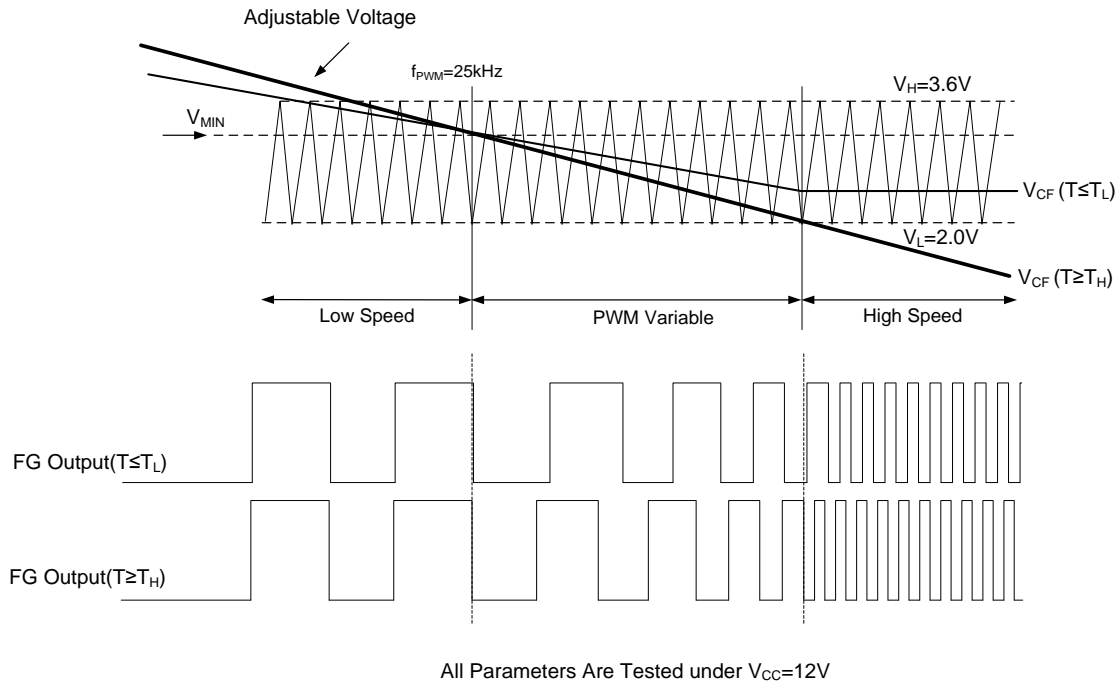

Speed Control and Minimum Speed Setting

Minimum Speed Setting

The minimum speed setting prevents the motor speed dropping below a setting speed when the speed demand is too low (i.e. PWM voltage is closer to 3.6V)

When the CF pin voltage is higher than the V_{MIN} voltage, the V_{MIN} voltage is compared with the internal triangular wave to generate the output PWM duty. Therefore, setting the V_{MIN} to certain fixed voltage forces the V_{MIN} to control the speed even when the CF voltage is higher.

If V_{MIN} setting is not used or application does not need to set the minimum speed, connect the V_{MIN} to CF directly.

Rotor Lock Detect and OFF Time Setting

The capacitor C4 from CT pin to the ground provides the timing for the lock detect and auto-restart. The capacitor C4 is charges and discharged by the CT pin at a fixed rate depending on the mode of operation (fan operation status) and therefore the value of the C4 to gives lock-detect time (T_{LCKDET}) and lock time (T_{OFF}) before next auto-start retry.

The AM4964 returns the C4 voltage to the low threshold, V_{CTL} (1.77V), each time the Hall sensor provides the commutation signal. C4 is charged with I_{CHG} which is typically 2 μ A. If the voltage on the C4 reaches the high threshold, V_{CTH} (3.7V) before the next Hall signal change, the output will be shut down and the device will enter lock condition.

$$t_{LCKDET} = \frac{C4 (V_{CTH} - V_{CTL})}{I_{CHG}}$$

The thresholds voltage and charge current are fixed, therefore the t_{LCKDET} time depends only on the value of C4.

$$t_{LCKDET} = C4 \times 1 \times 10^6$$

For C4 of 0.47 μ F, t_{LCKDET} is 0.47s.

Applications Note (cont.)

If lock detection causes device to enter output shutdown, the CT pin will discharge the C4 capacitor with I_{DHG} provide t_{OFF} period. The t_{OFF} is the time the device waits before next auto-restart. During t_{OFF} period, the C4 is discharged for the high threshold, V_{CTH} to low threshold V_{CTL} at the discharge current I_{DHG} which is typically $0.2\mu A$.

$$t_{OFF} = \frac{C4 (V_{CTH} - V_{CTL})}{I_{CHG}}$$

The thresholds voltage and discharge current are fixed, therefore the t_{OFF} time depends only on the value of C4.

$$t_{OFF} = C4 \times 10 \times 10^6$$

For CT of $0.4\mu s$, t_{OFF} is 4.7s before the next auto restart.

Thermal Shutdown

AM4964 includes a thermal shutdown function. When the device junction temperature is higher than $+176^{\circ}C$ typical, the thermal shutdown function is triggered and the low side output transistors in H bridge driver will be turned off. When the IC junction temperature drops below $+148^{\circ}C$ typical, the device will recover.

Status Output - FG Output

The FG output pin is an open collector output which switches ON (pulled low) and OFF (pulled high with an external resistor) depending on the magnetic phase of the motor. The external pull up resistor should be connected to the FG pin.

The FG pin has series resistors of 25Ω typical integrated in the FG output structure to increased robustness against reverse supply connection of the FG to ground. The typical value for external pull-up on FG is $10k\Omega$.

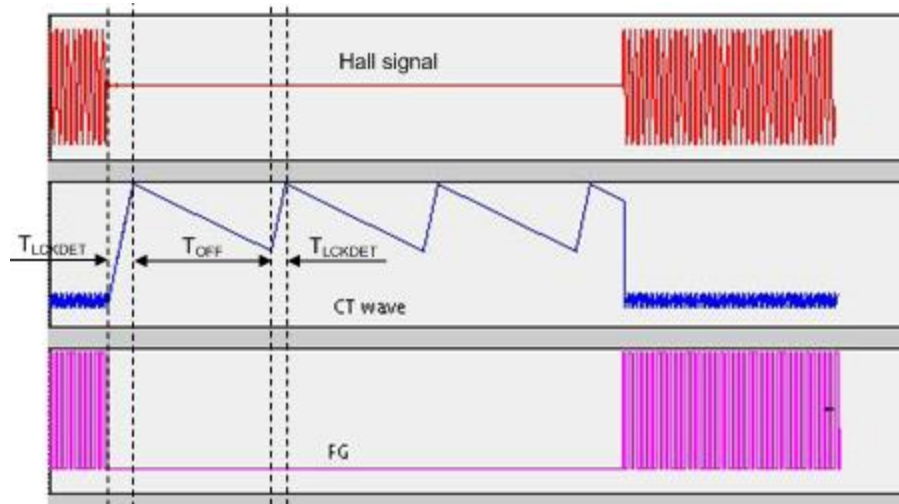

Ordering Information

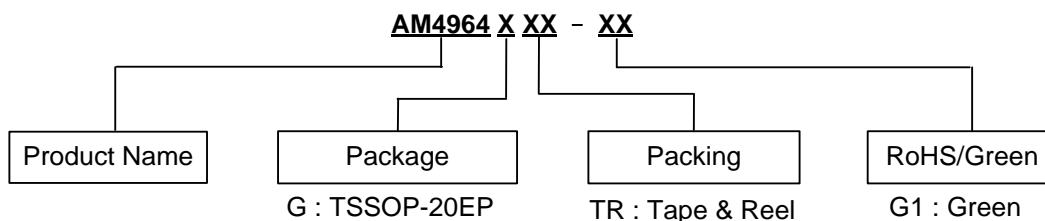

Diodes IC's Pb-free products with "G1" suffix in the part number, are RoHS compliant and green.

Package	Temperature Range	Part Number	Marking ID	Packing
TSSOP-20EP	-30 to +90°C	AM4964GTR-G1	AM4964GG	4000/Tape & Reel

Marking Information

(Top View)

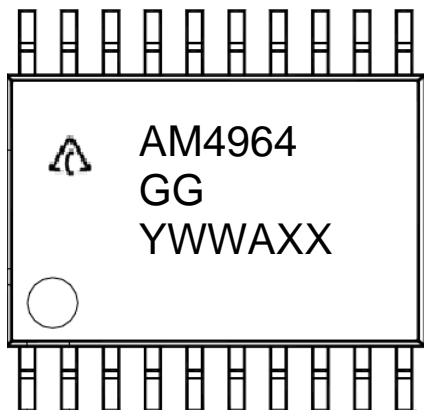

First and Second lines: Logo and Marking ID
 Third Line: Date Code
 Y: Year 0 to 9
 WW: Week 00 to 52 (Work Week of Molding)
 A: Assembly House Code
 XX: 7th and 8th Digits: Batch No.

Part Number	Package	Marking ID
AM4964GTR-G1	TSSOP-20EP	AM4964GG

Package Outline Dimensions (All dimensions in mm(inch).)

(1) Package Type: TSSOP-20EP

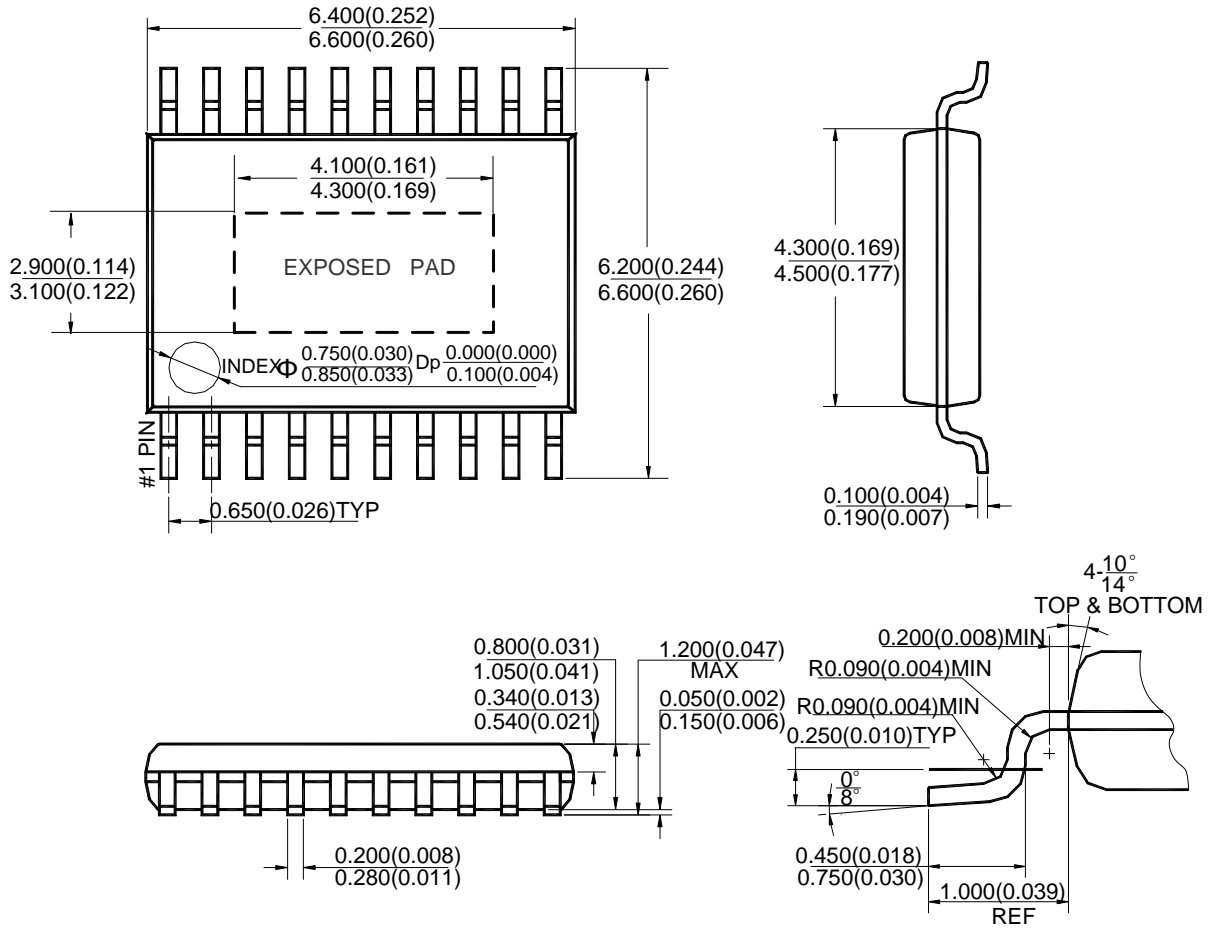

Note: Eject hole, oriented hole and mold mark is optional.

NEW PRODUCT

Suggested Pad Layout

(1) Package Type: TSSOP-20EP

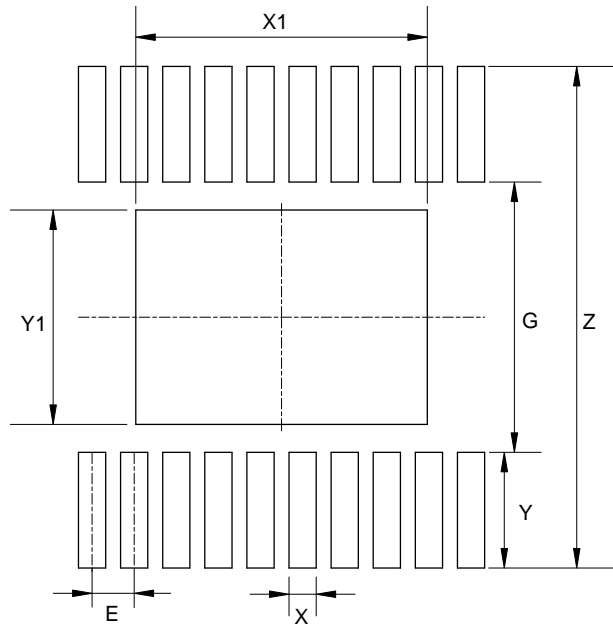

Dimensions	Z (mm)/(inch)	G (mm)/(inch)	X (mm)/(inch)	Y (mm)/(inch)
Value	7.720/0.304	4.160/0.164	0.420/0.017	1.780/0.070
Dimensions	E (mm)/(inch)	X1 (mm)/(inch)	Y1 (mm)/(inch)	–
Value	0.650/0.026	4.500/0.177	3.300/0.130	–

IMPORTANT NOTICE

DIODES INCORPORATED MAKES NO WARRANTY OF ANY KIND, EXPRESS OR IMPLIED, WITH REGARDS TO THIS DOCUMENT, INCLUDING, BUT NOT LIMITED TO, THE IMPLIED WARRANTIES OF MERCHANTABILITY AND FITNESS FOR A PARTICULAR PURPOSE (AND THEIR EQUIVALENTS UNDER THE LAWS OF ANY JURISDICTION).

Diodes Incorporated and its subsidiaries reserve the right to make modifications, enhancements, improvements, corrections or other changes without further notice to this document and any product described herein. Diodes Incorporated does not assume any liability arising out of the application or use of this document or any product described herein; neither does Diodes Incorporated convey any license under its patent or trademark rights, nor the rights of others. Any Customer or user of this document or products described herein in such applications shall assume all risks of such use and will agree to hold Diodes Incorporated and all the companies whose products are represented on Diodes Incorporated website, harmless against all damages.

Diodes Incorporated does not warrant or accept any liability whatsoever in respect of any products purchased through unauthorized sales channel.

Should Customers purchase or use Diodes Incorporated products for any unintended or unauthorized application, Customers shall indemnify and hold Diodes Incorporated and its representatives harmless against all claims, damages, expenses, and attorney fees arising out of, directly or indirectly, any claim of personal injury or death associated with such unintended or unauthorized application.

Products described herein may be covered by one or more United States, international or foreign patents pending. Product names and markings noted herein may also be covered by one or more United States, international or foreign trademarks.

This document is written in English but may be translated into multiple languages for reference. Only the English version of this document is the final and determinative format released by Diodes Incorporated.

LIFE SUPPORT

Diodes Incorporated products are specifically not authorized for use as critical components in life support devices or systems without the express written approval of the Chief Executive Officer of Diodes Incorporated. As used herein:

A. Life support devices or systems are devices or systems which:

1. are intended to implant into the body, or
2. support or sustain life and whose failure to perform when properly used in accordance with instructions for use provided in the labeling can be reasonably expected to result in significant injury to the user.

B. A critical component is any component in a life support device or system whose failure to perform can be reasonably expected to cause the failure of the life support device or to affect its safety or effectiveness.

Customers represent that they have all necessary expertise in the safety and regulatory ramifications of their life support devices or systems, and acknowledge and agree that they are solely responsible for all legal, regulatory and safety-related requirements concerning their products and any use of Diodes Incorporated products in such safety-critical, life support devices or systems, notwithstanding any devices- or systems-related information or support that may be provided by Diodes Incorporated. Further, Customers must fully indemnify Diodes Incorporated and its representatives against any damages arising out of the use of Diodes Incorporated products in such safety-critical, life support devices or systems.

Copyright © 2014, Diodes Incorporated

www.diodes.com