

SPECIFICATION

- Part No.** : **OMB.868.B08F21**
- Description** : 868MHz 8dBi Omni Directional
Outdoor Antenna
- Features** : Omni-Directional Radiation
Collinear
ISM 868 MHz Band
8dBi Peak gain
Robust design for all weather operation
IP65 waterproof
1474mm in length, 720 g in weight
N type Female connector
Wall/Pole mount bracket included
RoHS compliant



1. Introduction

The OMB.868.B08F21 is a fiberglass omni-directional outdoor antenna, operating in 868 MHz ISM band. The antenna has an 8dBi high peak gain, providing the largest coverage area for Low Power Radio (UNB Sigfox, LPRN, LoRA) and mesh networks. Typical applications are in IoT, metering, industrial/environmental monitoring and remote asset monitoring.

The OMB.868 operates at 868MHz, one of the most widely used license free ISM bands, with a 8dBi peak gain. The omni-directional antenna collinear dipole design means it radiates uniformly in the azimuth with a high gain, providing coverage over long distances, thus minimizing the amount of cells or nodes needed in a network.

The UV resistant fiberglass housing enables the OMB antenna to be weathered in all kinds of harsh environments, making it more robust and safer than traditional whip antennas. It has been designed to withstand high wind load. The integrated aluminum mounting bracket is perfect for directly mounting the antenna onto a pole or a wall. The connector is industry standard N-type female. Connector can be customized subject to MOQ. Other frequencies and gains are available. Contact Taoglas regional sales office for more details.

2. Specification

ELECTRICAL	
Standard	ISM 868
Band	860-870 MHz
Antenna Type	Collinear Dipole Array
Peak Gain	8 dBi
Polarization	Vertical
Impedance	50 ohms
Max Input Power	50 watts
VSWR	1.5:1
Radiation	Omni-Directional
Vertical Beamwidth	13 Deg
Horizontal Beamwidth	360 Deg
Internal Material	Copper
Connector	N Type Female
MECHANICAL	
Length	1474 mm(Max)
Bracket Dimension	70 x 73mm(Max)
Antenna Weight	720g
Mounting Accessories Weight	70g
Application	Indoor/Outdoor
Radome Material	White Fiberglass
Bracket Material	Aluminum
Mount Style	Pole Mount/Wall Mount
Mount Hardware Material	Stainless Steel
Wind Resistance	>150mph (>241km/h)
Waterproof	IP65

ENVIRONMENTAL	
Storage Temperature	-40°C to +85°C
Operating Temperature	-40°C to +85°C
Operating Humidity	10%~90% non-condensing
Storage Humidity	5%~90% non-condensing

3. Antenna Characteristics

3.1 VSWR

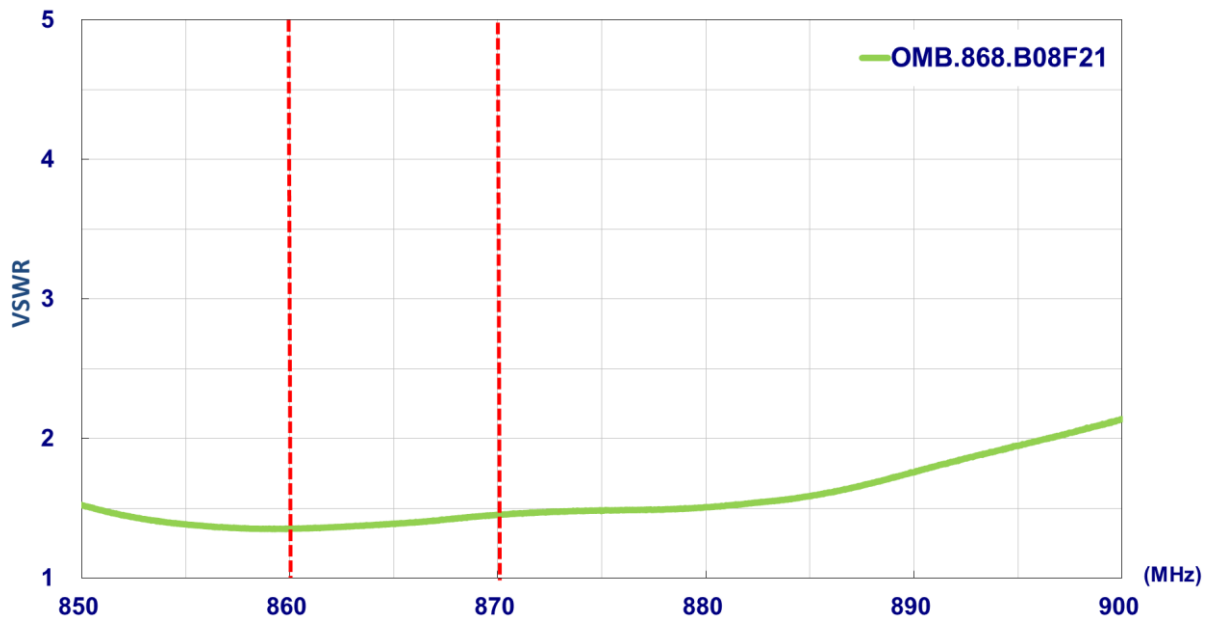

3.2 Peak Gain

E-plane

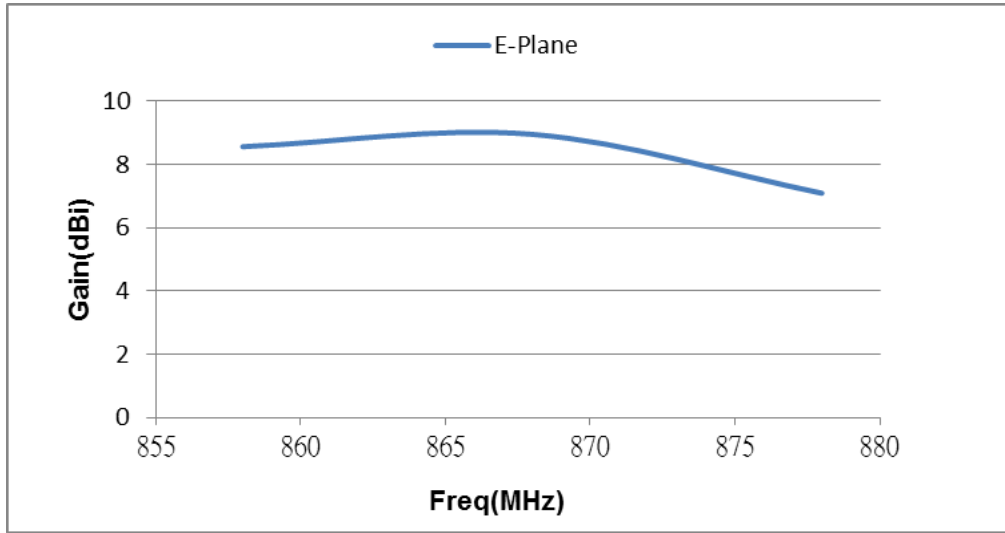

H-plane

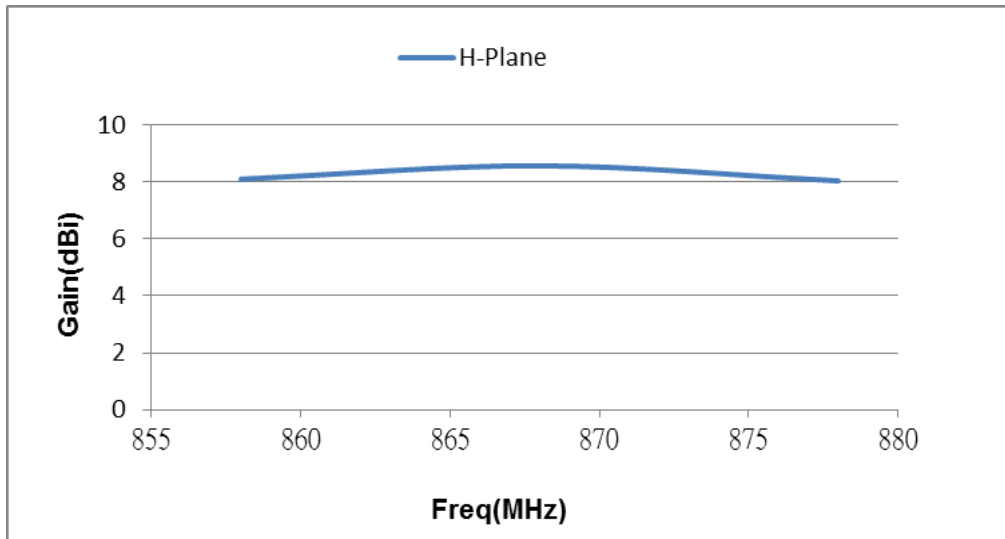

4. Antenna Radiation Pattern

4.1 Measurement Setup

Vertical Pattern – E plane

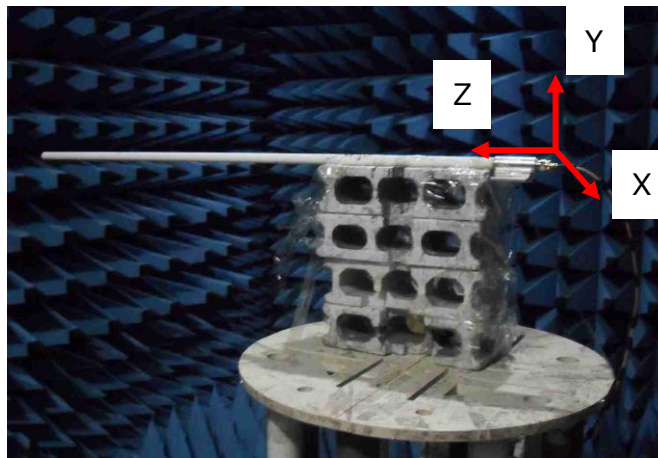

Horizontal Pattern – H plane

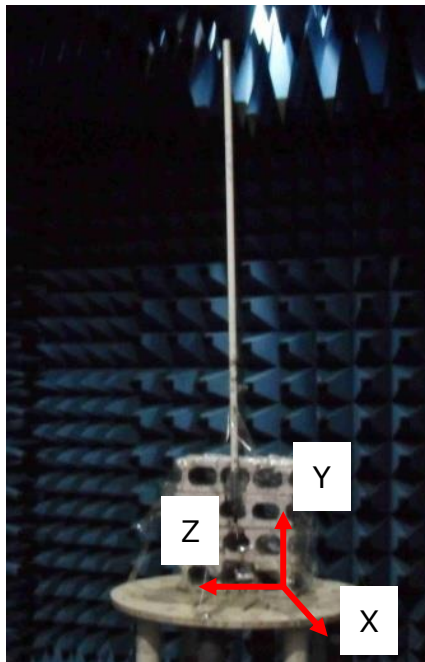

4.2 2D Radiation Pattern

Vertical Pattern – E plane

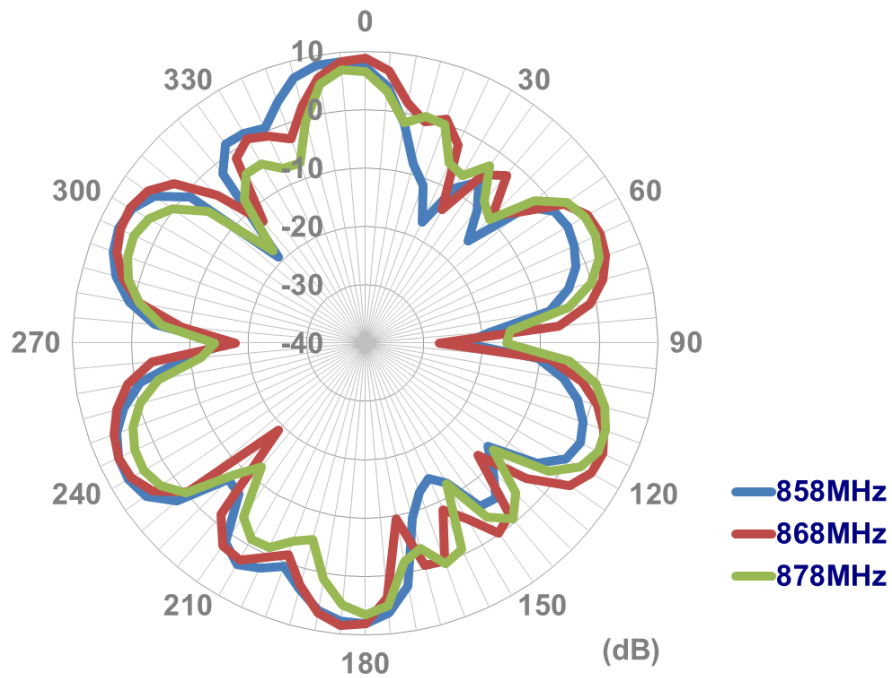

Horizontal Pattern – H plane

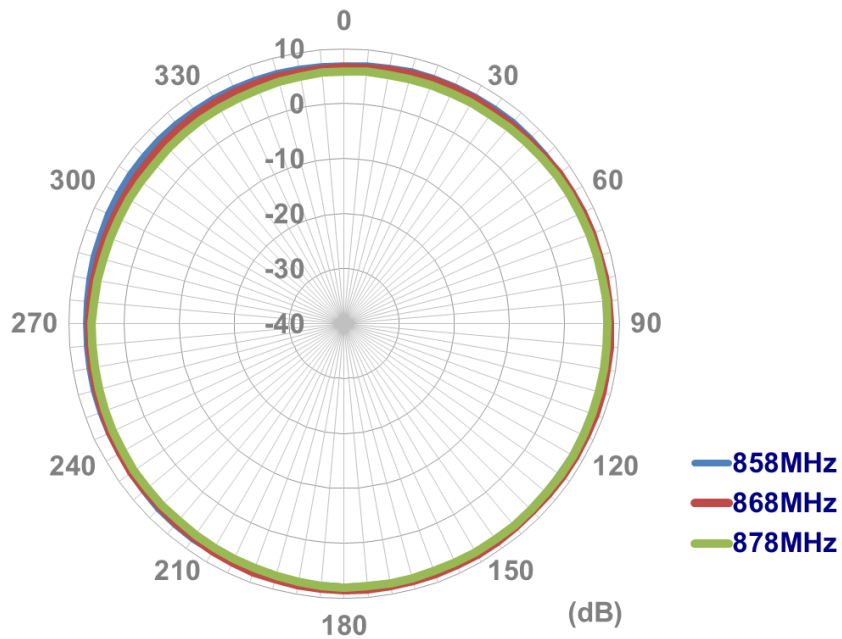

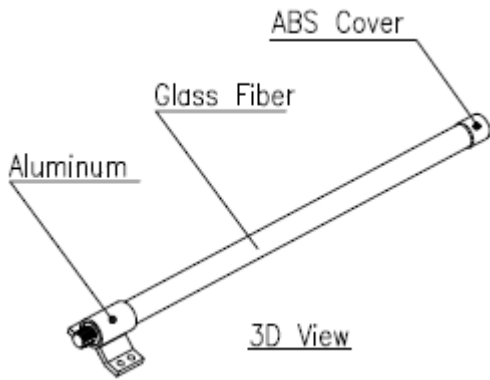

U-Bolt

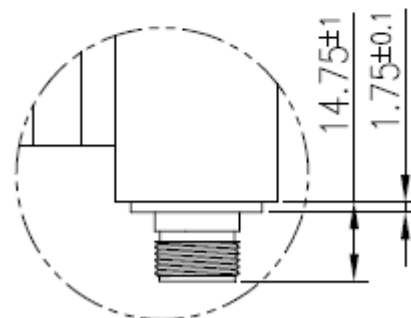
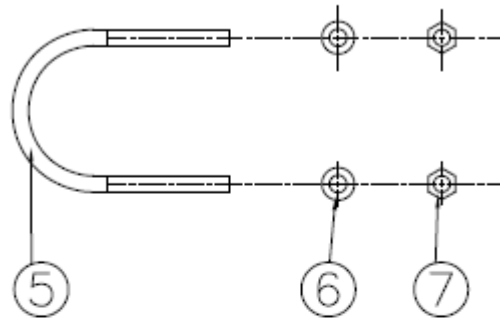

Detail A
Scale:4:1

Unit : mm

	Name	Material	Finish	QTY
1	OMB.868 Antenna	Fiberglass	White	1
2	Cover	ABS	Silver	1
3	Bracket	Aluminum	Silver	1
4	N Type(F)	Brass	Ni Plated	1
5	M6 U Bolt	Stainless Steel	Silver	1
6	M6 Washer	Stainless Steel	Silver	2
7	M6 Nut	Stainless Steel	Silver	2

6. Packaging

Packaging Specifications

1 OMB.868.B08F21 per tube
Tube Dimensions - $\varnothing 80\text{mm}$ *Height 1530mm
Total Weight - 1250g

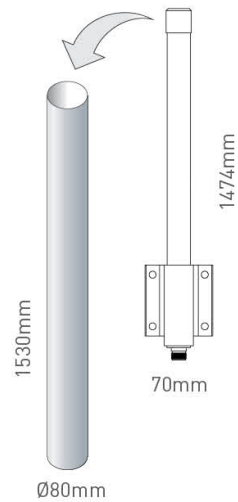

10 tubes per carton
Carton Dimensions - 1550*430*170mm
Weight - 15.3Kg

