



XPress™ DR+ Industrial Device Server User Guide

Intellectual Property

© 2017 Lantronix, Inc. All rights reserved. No part of the contents of this book may be transmitted or reproduced in any form or by any means without the written permission of Lantronix.

Lantronix is a registered trademark of Lantronix, Inc in the United States and other countries. *XPress* and *DeviceInstaller* are trademarks of Lantronix, Inc.

Patented: <http://patents.lantronix.com>; additional patents pending.

Windows is a trademark of Microsoft Corporation. *Mozilla* and *Firefox* are registered trademarks of the Mozilla Foundation. All other trademarks and trade names are the property of their respective holders.

Warranty

For details on the Lantronix warranty policy, please go to our Web site at www.lantronix.com/support/warranty.

Contacts

Lantronix, Inc.
7535 Irvine Center Drive
Suite 100
Irvine, CA 92618, USA

Toll Free: 800-526-8766
Phone: 949-453-3990
Fax: 949-453-3995

Technical Support Online: www.lantronix.com/support

Sales Offices

For a current list of our domestic and international sales offices, go to the Lantronix web site at www.lantronix.com/about/contact

Disclaimer & Revisions

Operation of this equipment in a residential area is likely to cause interference, in which case the user, at his or her own expense, will be required to take whatever measures may be required to correct the interference.

Attention: *This product has been designed to comply with the limits for a Class A digital device pursuant to Part 15 of FCC Rules. These limits are designed to provide reasonable protection against such interference when operating in a commercial environment. This equipment generates, uses, and can radiate radio frequency energy, and if not installed and used in accordance with this guide, may cause harmful interference to radio communications.*

This Class A digital apparatus complies with Canadian ICES-003.

Cet appareil numérique de la classe A est conforme à la norme NMB-003 du Canada.

Changes or modifications to this device not explicitly approved by Lantronix will void the user's authority to operate this device.

The information in this guide may change without notice. The manufacturer assumes no responsibility for any errors that may appear in this guide.

Revision History

Date	Rev.	Comments
March 2006	A	Initial document.
October 2006	B	Added description of wireless functionality.
June 2008	C	Added RoHs notice.
August 2013	D	Removed reference to FM cert and GS mark from xPress IO User Guide and updated LTX address.
December 2017	E	Updated enhanced password information.

Table of Contents

Chapter 1: Using This Guide	11
Purpose and Audience _____	11
Summary of Chapters _____	11
Additional Documentation _____	12
Chapter 2: Introduction	13
Product Description _____	13
Industrial Automation Protocols _____	15
Network Protocols (Serial Tunneling) _____	15
XPress DR+ Application Examples _____	16
Addresses and Port Numbers _____	17
Hardware Address _____	17
IP Address _____	17
Port Numbers _____	17
Configuration Methods _____	18
Chapter 3: Installation and Hardware	19
What's in the Box? _____	19
What Must the User Provide? _____	19
Physically Connecting the XPress DR+ _____	19
XPress DR+ Front Panel _____	20
Serial Interface _____	21
Screw Terminal Serial Connectors _____	22
9-Pin RS-232 to Serial RJ45 Cable (P/N 500-103) _____	23
Ethernet Interface _____	24
Multi-Drop Ethernet Connections _____	25
Power Requirements _____	25
Reset Switch _____	25
LEDs _____	26
Dimensions _____	27
Wall Mount Bracket _____	28
Product Information Label _____	28
Chapter 4: XPress DR+W	29
Application Examples _____	29

Serial Tunneling – Network _____	29
Ad Hoc Network _____	30
Serial Tunneling – Infrastructure _____	30
Ad Hoc XPress DR+W Connection _____	31
Physically Connecting the XPress DR+W _____	31
Front Panel Description _____	32
LEDs _____	33
Required Information for Initial Configuration _____	33
Hardware Address _____	33
IP Address _____	34
WLAN Settings _____	34
Installing the XPress DR+W for Initial Configuration _____	34
Server Configuration (Option 0) _____	35
Network Mode (XPress DR+W only) _____	35
IP Address _____	35
Set Gateway IP Address _____	36
Netmask: Number of Bits for Host Part _____	36
Change Telnet/Web Manager Password _____	36
Change DHCP Device Name: _____	36
WLAN Configuration (Option 4) _____	37
Topology _____	37
Network Name (SSID) _____	37
Adhoc Network Channel _____	37
Security _____	37
WEP _____	38
WPA _____	39
WPA2/802.11i _____	40
Fixed or Automatic Data Rate _____	40
Transmission Data Rate _____	41
Next Steps _____	41
Chapter 5: Using DeviceInstaller _____	42
Installing DeviceInstaller _____	42
Assigning an IP Address _____	42
Accessing the XPress DR+ Using DeviceInstaller _____	43
Viewing the Current Configuration _____	43
Chapter 6: Configuration Using Web Manager _____	46
Installing the DeviceInstaller Utility _____	46
Accessing XPress DR+ Using DeviceInstaller _____	46

Network Configuration _____	48
Automatic IP Address Configuration _____	48
Static IP Address Configuration _____	49
Server Configuration _____	50
Host List Configuration _____	51
Channel Configuration _____	52
Serial Settings _____	53
Connection Settings - TCP _____	55
Connection Settings - UDP _____	57
WLAN Configuration (XPress DR+W only) _____	59
Applying Settings _____	63
Factory Defaults _____	63
Chapter 7: Configuration Using Telnet or Serial Port (Setup Mode) _____	64
Accessing Setup Mode _____	64
Telnet Connection _____	64
Serial Port Connection _____	65
Exiting Setup Mode _____	66
Chapter 8: Setup Mode: Server Configuration _____	67
Server Configuration (Option 0) _____	67
Network Mode (XPress DR+W only) _____	67
IP Address _____	67
Set Gateway IP Address _____	68
Netmask: Number of Bits for Host Part _____	68
Change Telnet Configuration Password _____	69
DHCP Name _____	69
Chapter 9: Setup Mode: Channel Configuration _____	70
Channel 1 (Option 1) and Channel 2 (Option 2) _____	70
Baudrate _____	70
I/F (Interface) Mode _____	71
Flow _____	72
Port Number _____	72
Connect Mode _____	73
a) Incoming Connection _____	74
b) Response _____	74
c) Active Startup _____	74
d) Datagram Type _____	76
e) Modem Mode _____	76

Send the Escape Sequence (+++) in Modem Mode_____	79
Auto Increment Source Port _____	79
Remote IP Address _____	79
Remote Port _____	80
DisConnMode _____	80
Flush Mode (Buffer Flushing) _____	81
Pack Control _____	81
Packing Interval _____	82
Trailing Characters _____	82
Send Characters _____	82
DisConnTime (Inactivity Timeout)_____	82
Send Characters _____	83
Telnet Terminal Type _____	83
Channel (Port) Password _____	83
WLAN Settings (XPress DR+W Only) _____	83
Topology _____	84
Network Name (SSID)_____	84
Adhoc Network Channel _____	84
WEP _____	85
WPA _____	86
WPA2/802.11i _____	87
Fixed or Automatic Data Rate _____	87
Transmission Data Rate _____	87
Enable Power Management _____	88
Chapter 10: Setup Mode: Advanced Settings	89
Expert Settings (Option 5)_____	89
TCP Keepalive time in seconds_____	89
ARP Cache timeout in seconds_____	89
Disable Monitor Mode at bootup _____	89
HTTP Port Number _____	90
MTU Size_____	90
Enable alternate MAC _____	90
Security Settings (Option 6) _____	90
Disable SNMP _____	91
SNMP Community Name _____	91
Disable Telnet Setup_____	91
Disable TFTP Firmware Upgrade _____	91
Disable Port 77FE (Hex) _____	91

Disable Web Server _____	92
Disable Web Setup _____	92
Disable ECHO Ports _____	92
Enable Enhanced Password _____	92
Default Settings (Option 7) _____	92
Channel 1 and Channel 2 Configuration Settings _____	92
Expert Settings _____	92
Security Settings _____	93
WLAN Settings (XPress DR+W only) _____	93
Chapter 11: Firmware Upgrades	94
Obtaining Firmware _____	94
Reloading Firmware _____	94
Using TFTP: Graphical User Interface _____	94
Using TFTP: Command Line Interface _____	95
Recovering the Firmware Using the Serial Port and DeviceInstaller _____	95
Chapter 12: Monitor Mode	97
Entering Monitor Mode Using the Serial Port _____	97
Entering Monitor Mode Using the Network Port _____	97
Monitor Mode Commands _____	97
Chapter 13: Troubleshooting and Technical Support	100
Problems and Error Messages _____	100
Technical Support _____	103
Appendix A: Technical Specifications	104
Appendix B: Lantronix Cables and Adapters	106
Appendix C: Alternative Methods of Assigning an IP Address	107
DHCP _____	107
AutoIP _____	107
BOOTP _____	108
ARP and Telnet _____	108
Appendix D: Binary to Hexadecimal Conversions	109
Converting Binary to Hexadecimal _____	109
Conversion Table _____	109
Scientific Calculator _____	109
Appendix E: Compliance Information	111
Declaration of Conformity _____	111
XPress DR+W Regulatory Information _____	113

USA Federal Communications Commission (FCC) Notice _____	113
Canada – Industry Canada Notice _____	113
RoHS, REACH and WEEE Compliance Statement _____	114
Europe – R&TTE Directive 99/5/EC, Wireless Notice _____	115
Australia & New Zealand – Wireless Notice _____	115

List of Figures

Figure 2-1. XPress DR+ (Front)	14
Figure 2-2. Example of Serial Tunneling	16
Figure 2-3. Example of Cascading Multiple XPress DR+ Units	17
Figure 2-4. Sample Hardware Address	17
Figure 3-1. Typical Configuration	20
Figure 3-2. Front of XPress DR+	21
Figure 3-3. RJ45 Connector – Front View.....	22
Figure 3-4. Screw Terminal Ports.....	22
Figure 3-5. Termination Resistor for 2-Wire Connection.....	23
Figure 3-6. Lantronix P/N 500-103 RJ45-DB9F Serial Cable Pinout	23
Figure 3-7. Multi-Drop Ethernet Connections.....	25
Figure 3-8. Reset Switch	26
Figure 3-9. LEDs on the XPress DR	26
Figure 3-10. Dimensions	27
Figure 3-11. Wall Mount Bracket.....	28
Figure 3-12. Product Label	28
Figure 4-1. Serial Tunneling Infrastructure Network Example	29
Figure 4-2. Ad Hoc Network Example	30
Figure 4-3. Serial Tunneling Infrastructure Example.....	30
Figure 4-4. Direct XPress DR+W - to- XPress DR+W Connection	31
Figure 4-5. Typical XPress DR+W Configuration.....	32
Figure 4-6. XPress DR+W Front Panel Layout	32
Figure 4-7. Network Mode	35
Figure 4-8. Server Settings.....	35
Figure 6-1. Lantronix Web Manager.....	47
Figure 6-2. Network Settings	48
Figure 6-3. Server Settings.....	50
Figure 6-4. Hostlist Settings	52
Figure 6-5. Channel Serial Settings	53
Figure 6-6. TCP Connection Settings.....	55
Figure 6-7. UDP Connection Settings	58
Figure 6-8. WLAN Settings – Ad Hoc Network Type	60
Figure 6-9. WLAN Settings – Infrastructure Network Type	61
Figure 7-1. MAC Address	65
Figure 7-2. Setup Menu Options	65
Figure 8-1. Network Mode	67
Figure 8-2. Server Settings.....	67
Figure 9-1. Serial Port Parameters.....	70
Figure 9-2. Manual Connection Address Example.....	75
Figure 9-3. Hostlist Option.....	76
Figure 10-1. Expert Settings.....	89
Figure 10-2. Security Settings	90
Figure 11-1. TFTP Window	95
Figure 12-1. Accessing Monitor Mode.....	97

List of Tables

Table 3-1. RJ45 Serial Connector Pinouts	22
Table 3-2. Serial Screw Terminal Pinout for RS422 (4-Wire)	22
Table 3-3. Serial Screw Terminal Pinout for RS485 (2-Wire)	22
Table 3-4. Ethernet Interface Signals	24
Table 3-5. Typical RJ45 Connector	24
Table 3-6. XPress DR+ LED Functions.....	27
Table 4-1. XPress DR+W LED Functions	33
Table 4-2. BootP/DHCP/AutoIP options	35
Table 4-3. Standard IP Network Netmasks	36
Table 5-1. Viewing Current Settings.....	43
Table 8-1. BootP/DHCP/AutoIP options.....	68
Table 8-2. Standard IP Network Netmasks	68
Table 9-1. Interface Mode Options	71
Table 9-2. Common Interface Mode Settings.....	71
Table 9-3. Flow Control Options.....	72
Table 9-4. Reserved Port Numbers.....	72
Table 9-5. Connect Mode Options	73
Table 9-6. Modem Mode Messages	77
Table 9-7. Modem Mode Commands.....	78
Table 9-8. Disconnect Mode Options	80
Table 9-9. Flush Mode Options	81
Table 9-10. Pack Control Options	81
Table 11-1. Firmware Files.....	94
Table 12-1. Monitor Mode Commands.....	98
Table 13-1. Problems and Error Messages.....	100

Chapter 1: Using This Guide

Purpose and Audience

This manual describes the Lantronix® XPress™ DR+ and XPress™ DR+W device servers. These device servers are members of the XPress family that work with Industrial Automation Protocols. The XPress DR+ W has wireless as well as wired capability.

This guide provides the information needed to configure, use, and update the XPress DR+ device servers. It is for system administrators and those responsible for installing and maintaining these device servers.

Summary of Chapters

The remaining chapters in this guide include:

Chapter	Description
Chapter 2: Introduction	Describes the main features of the XPress DR+ and the protocols it supports.
Chapter 3: Installation and Hardware	Describes the unit's interfaces and power requirements. Provides instructions for physically connecting the unit.
Chapter 4: XPress DR+W	Describes the XPress DR+W and how to install and configure the unit initially.
Chapter 5: Using DeviceInstaller	Provides information for getting your unit up and running, using DeviceInstaller to assign an IP address.
Chapter 6: Configuration Using Web Manager	Details using the Web Manager to set parameters such as port and server properties.
Chapter 7: Configuration Using Telnet or Serial Port (Setup Mode)	Provides instructions for accessing Setup Mode (command line interface) using a Telnet connection through the network or a terminal or terminal emulation program through the serial port.
Chapter 8: Setup Mode: Server Configuration	Details the network (server) settings
Chapter 9: Setup Mode: Channel Configuration	Details the serial port settings.
Chapter 10: Setup Mode: Advanced Settings	Details email, expert, and security settings and explains how to reset the unit to factory default values.
Chapter 11: Firmware Upgrades	Provides instructions for obtaining the latest firmware and updating the XPress DR+.
Chapter 12: Monitor Mode	Provides instructions for accessing and using the command line interface for monitoring the network and diagnosing problems.

Chapter	Description
Chapter 13: Troubleshooting and Technical Support	Describes common problems and error messages and how to contact Lantronix Technical Support.
Appendix A: Technical Specifications	Lists technical information about the unit.
Appendix C: Alternative Methods of Assigning an IP Address	Describes other ways to assign an IP address, for example, though ARP and Telnet.
Appendix D: Binary to Hexadecimal Conversions	Provides instructions for converting binary numbers to hexadecimals.
Appendix E: Compliance Information	Provides the Declaration of Conformity and other regulatory information.
Appendix F: Warranty	

Additional Documentation

Visit the Lantronix Web site at www.lantronix.com/support/documentation for the latest documentation and the following additional documentation.

Document	Description
XPress DR+ Quick Start or XPress DR+W Quick Start	Provides the steps for getting the XPress DR+ or XPress DR+W up and running.
Com Port Redirector Quick Start and Com Port Redirector Online Help	Provides information on using the Windows®-based utility to create a virtual com port.
DeviceInstaller Online Help	Provides information on using DeviceInstaller® to locate Lantronix devices on the network and configure IP addresses.
"Live" tutorials on the Lantronix Web Site	Explain and demonstrate assigning an IP address and setting up the unit and the Redirector. See http://ts.lantronix.com/tutorials.html . Note: The instructions for the UDS products apply to the XPress DR+ as well.
Protocol Documentation	Provides guides for the protocols, such as Modbus Bridge and Multi-Master DF1, which you can load on the XPress DR+.

Chapter 2: Introduction

This chapter provides basic information about the wired and wireless versions of the XPress DR+. The wireless version has two modes of operation: wireless and wired. In wired mode, the wireless functionality is not used, and the unit behaves identically to the wired XPress DR+. In wireless mode, the unit's behavior is wireless to serial, and the Ethernet ports are not functional.

Unless otherwise noted, information in this User Guide applies to both versions of the product. Information specific to the wireless version of the XPress DR+ unit is in [Chapter 4: XPress DR+W](#).

Note: In this User Guide we sometimes refer to the XPress DR+W as "the wireless unit" or the "wireless device server."

Product Description

The Lantronix XPress DR+ Industrial Device Server is a robust, feature-rich, and cost effective way to network-enable equipment in an industrial automation environment. The XPress DR+ provides two serial ports, two switched Ethernet ports, a wide power input range, and expanded environmental specifications, making it an ideal solution for connecting multiple asynchronous RS232, RS422, or RS485 serial devices to an Ethernet network.

The internal two-port Ethernet switch allows the XPress DR+ to cascade connections from a single network drop to another Ethernet device or from one XPress DR+ to another and another, and so on. By leveraging a single network drop to connect multiple devices, the XPress DR+ greatly reduces device connectivity costs, reduces cabling cost and simplifies system changes and device moves.

By encapsulating serial data and transporting it over Ethernet, the XPress DR+ allows virtual serial links over Ethernet and IP (TCP/IP, UDP/IP) networks. As a result, you can extend limited distance, point-to-point, direct serial connections within the plant, throughout the facility, or across the global enterprise.

The XPress DR+ provides an impressive list of features and functions enabling multiple industrial devices to be connected, controlled, configured, managed, and updated over a network. With two serial ports and two auto-sensing Ethernet ports, the XPress DR+ can easily connect multiple serial devices to a network and cascade from one XPress DR+ to another from a single network drop.

Types of supported devices:

- ◆ Programmable controllers (PLCs)
- ◆ Process controllers
- ◆ Motor drive controllers
- ◆ Power monitoring equipment

- ◆ Human-machine interfaces
- ◆ Robots
- ◆ Flow meters
- ◆ Temperature monitoring equipment
- ◆ Scales
- ◆ Mixing stations
- ◆ Gas detection devices
- ◆ CNC Machines

The XPress DR+ can connect devices using various methods of TCP/IP communications, for example, through a TCP data channel, using UDP datagrams, or through a Telnet connection. Communication can be established from the XPress DR+ to a host computer or another device or from a host computer or device to the XPress DR+.

Figure 2-1. XPress DR+ (Front)

Note: For a diagram and description of XPress DR+W, see [Front Panel Description on page 32](#).

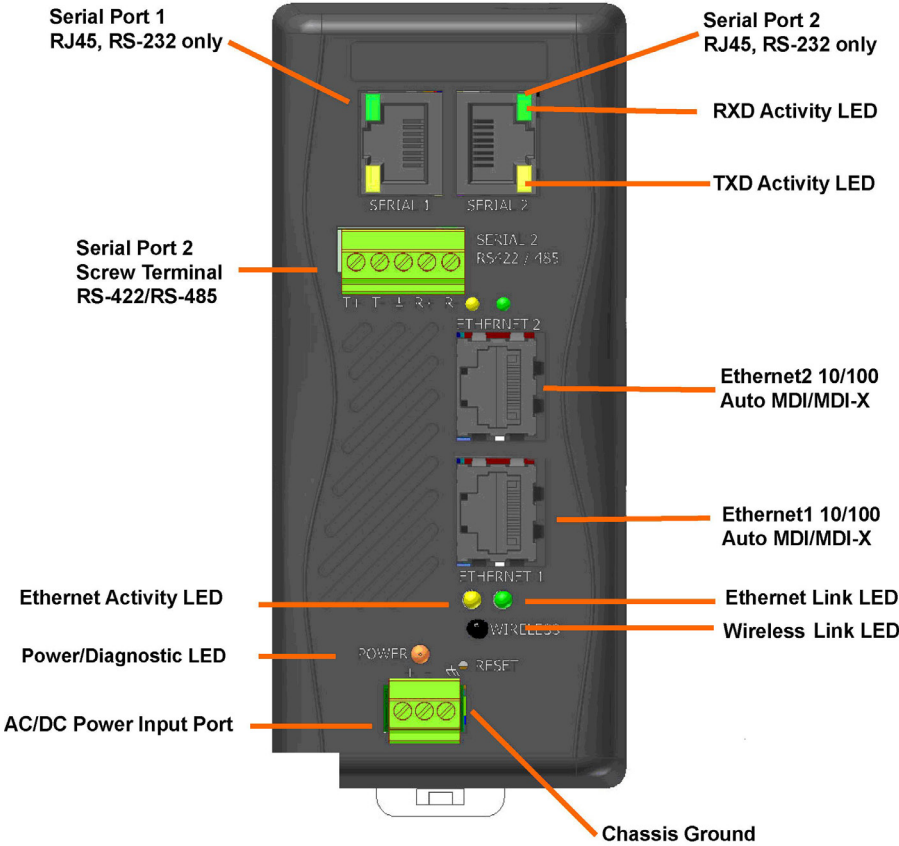

The XPress DR+ supports RS-232 through RJ45 connectors. It also supports RS-422/485 by means of screw terminals (Serial Port 2 only). It has two Ethernet Ports 10/100Base-T and –TX with Auto MDI/MDI-X by means of RJ45 connectors. You can use either Ethernet port for daisy-chained configuration.

Industrial Automation Protocols

The XPress DR+, adapted to multiple factory environments, can unite any mixture of equipment from industrial automation vendors into a single reliable pipeline. This new and open infrastructure opens the way for data to flow in real time from all your plant devices up to your IT layer.

The XPress DR+ is delivered with IAP Standard Tunneling protocol and can be loaded with industrial communication protocols. The suite of protocols includes DF1 Multi-Master (Rockwell Automation) and Modbus Bridge, which supports MODBUS/TCP, MODBUS/ASCII, and MODBUS/RTU (Schneider Electric). Where the IAP Standard Tunneling protocol is limited to standard ASCII device-to-device connections, the industrial protocols offer connections to other devices that require special formatting or features simultaneously.

For information about using any of the industrial communication protocols, see the specific protocol guides on the software CD or the Lantronix web site. Protocol firmware files are also on the CD.

Note: Please check the Lantronix web site for newer versions that may become available.

You can set up the unit using serial port 1 or remotely over Ethernet using Telnet or, when using the Standard Tunneling firmware, a web browser. The CD that comes with your device server includes DeviceInstaller, a Windows-based configuration software that simplifies the process of installing protocols and configuring them for use with attached devices. The XPress DR+ uses Flash memory for maintenance-free, non-volatile storage that allows fast system upgrades.

Network Protocols (Serial Tunneling)

The XPress DR+ uses TCP/IP protocols for network communication. The supported standards are ARP, UDP, TCP, ICMP, Telnet, TFTP, DHCP, AutoIP, MODBUS/TCP, and SNMP. For transparent connections, TCP/IP (binary stream) or Telnet protocols are used. You can perform firmware upgrades with the TFTP protocol.

The IP (Internet Protocol) protocol defines addressing, routing, and data-block handling over the network. The TCP (transmission control protocol) assures that no data is lost or duplicated, and that everything sent into the connection on one side arrives at the target exactly as it was sent.

For typical datagram applications, where devices interact with others without maintaining a point-to-point connection, UDP datagram is supported in the Standard Tunnel Protocol.

XPress DR+ comes loaded with Standard Tunnel Protocol. Standard Tunneling is a serial communications protocol used by most Lantronix device servers. You can configure it to Ethernet-enable most serial devices such as barcode scanners, weigh scales, operator panels, data access devices, alphanumeric displays, and thousands of intelligent serial devices.

Loading industrial protocols such as Modbus Bridge to an XPress DR+ changes the configuration dialogs. See the user guides on individual protocols for protocol-specific settings and configuration dialogs. Protocol manuals are on the software CD.

Note: This User Guide describes the setup and configuration dialogs for the Standard Tunnel Protocol.

XPress DR+ Application Examples

Note: For XPress DR+W application examples, see [Chapter 4: XPress DR+W](#).

Using a method called serial tunneling, the XPress DR+ encapsulates serial data into packets and transports them over Ethernet. Using two XPress DR+ units, connected by a network, you can extend virtual serial connections across a facility or around the world.

Figure 2-2. Example of Serial Tunneling

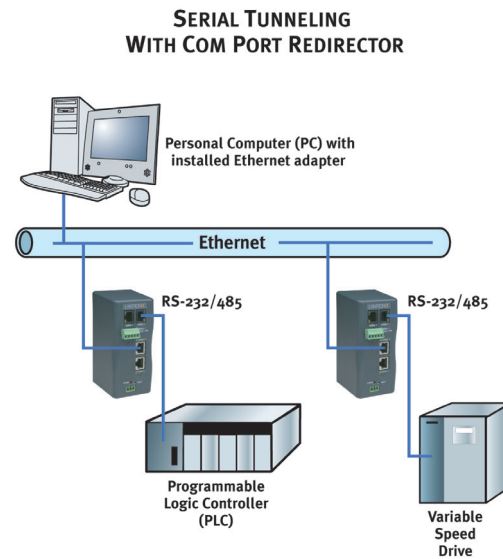

The internal two-port Ethernet switch allows the XPress DR+ to cascade connections from a single network drop to another Ethernet device or from one XPress DR+ to another and another, and so on.

Figure 2-3. Example of Cascading Multiple XPress DR+ Units

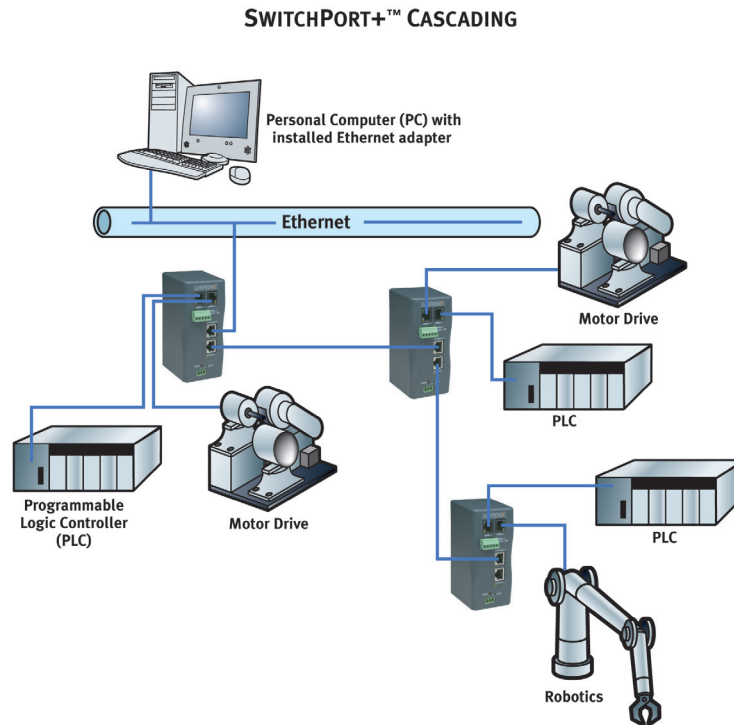

Note: For examples of wireless applications, see [Chapter 4: XPress DR+W](#).

Addresses and Port Numbers

Hardware Address

The hardware address is also referred to as the Ethernet address or MAC address. The first three bytes of the Ethernet address are fixed and read 00-20-4A, identifying the unit as a Lantronix product. The fourth, fifth, and sixth bytes are unique numbers assigned to each unit.

Figure 2-4. Sample Hardware Address

```
00-20-4A-14-01-18 or 00:20:4A:14:01:18
```

IP Address

Every device connected to an IP network must have a unique IP address. This address references the specific unit.

Port Numbers

Every TCP connection and every UDP datagram is defined by a destination IP address and a port number. For example, a Telnet application commonly uses port number 23. A port number is similar to an extension on a phone system.

You can associate the unit's serial channel (port) with a specific TCP/UDP port number. Port number 9999 is reserved for access to the unit's Setup (configuration) Mode.

Configuration Methods

After installation, the XPress DR+ requires configuration for the unit to operate correctly on a network. There are three basic methods for logging into the XPress DR+ and editing the configurable settings.

DeviceInstaller: Configures the IP address and other network settings on the XPress DR+ using a Graphical User Interface (GUI) on a PC attached to a network. (See [Chapter 5: Using DeviceInstaller.](#))

Web Manager: Through a web interface, configures the XPress DR+ settings using the Lantronix Web Manager. (See [Chapter 6: Configuration Using Web Manager.](#))

Serial and Telnet Ports: There are two approaches to accessing Setup Mode: making a Telnet connection to the network port (9999) or connecting a terminal (or a PC running a terminal emulation program) to the unit's serial port. To use DeviceInstaller for communication to an XPress DR+W over a wireless network, the WLAN network settings must be configured first.

Chapter 3: Installation and Hardware

What's in the Box?

Verify and inspect the contents of the package using the enclosed packing slip or the list below. If any item is missing or damaged, contact your place of purchase immediately.

- ◆ XPress DR+ or XPress DR+W
- ◆ Resource CD
- ◆ Quick Start Guide
- ◆ P/N: 500-103 RJ45-DB9F serial cable.
- ◆ P/N 930-029 antenna (XPress DR+W only)
- ◆ Accessory DIN-rail wall mount bracket
- ◆ 3 terminal screw connector for power input
- ◆ 5 terminal screw connector for serial port

What Must the User Provide?

- ◆ 9-30 VDC or 9-24 VAC power source
- ◆ CAT 5 Ethernet cable (for wired XPress DR+ and the wireless version operating in wired mode)

Physically Connecting the XPress DR+

Note: for information on physically connecting the XPress DR+W in wireless mode, see [Chapter 4: XPress DR+W](#).

Note: To comply with the hazardous location approval of the XPress DR+, the unit must be installed in a tool-secured enclosure and wiring must be installed in accordance with Division 2 wiring practices as specified by the NEC.

This section describes the procedures for getting your unit up and running. For a short version, see the Quick Start Guide. Detailed descriptions of the hardware components of the XPress DR+ follow this simple installation procedure.

The following diagram shows the basic connectivity of an XPress DR+ to the network and a serial device. The Lantronix-supplied P/N: 500-103 serial cable can be used on the RJ45 RS232 serial ports to connect the XPress DR+ to a PC or to a serial device that has a DB9M RS232 DTE interface. If the device being connected uses a different serial interface, please refer to page 23 for the serial interface pinout or to [Appendix B: Lantronix Cables and Adapters](#) for a list of serial cables or adapters.

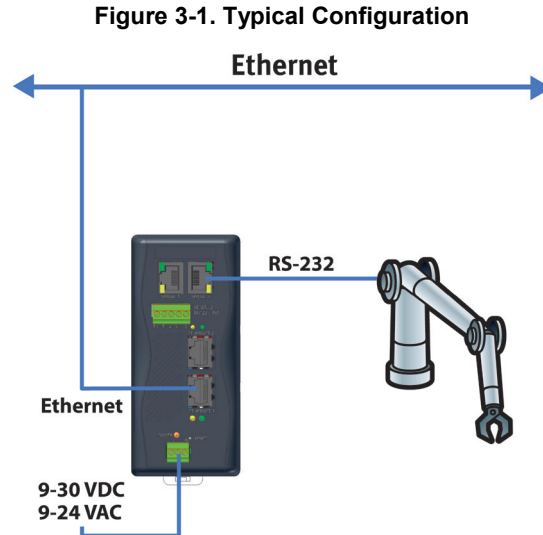

1. Connect a serial device to your XPress DR+. (See *Serial Interface* on page 21 for cable and connector specifications.)
2. Connect an Ethernet cable to the Ethernet port. (See *Ethernet Interface* on page 24.)
3. Supply power to your XPress DR+ using a 9-30 VDC or 9-24 VAC (2.3W maximum) source. (See *Power Requirements* on page 25.)
4. Supply power to the serial device.

Note: Connecting a device to an active Ethernet network can disrupt communications on the network. Make sure the device is configured for your application before connecting it to an active network

XPress DR+ Front Panel

The following figure illustrates the screw block connector pinouts and other components of the XPress DR+.

Note: For a description of the XPress DR+W front panel, see *Chapter 4: XPress DR+W*.

Figure 3-2. Front of XPress DR+

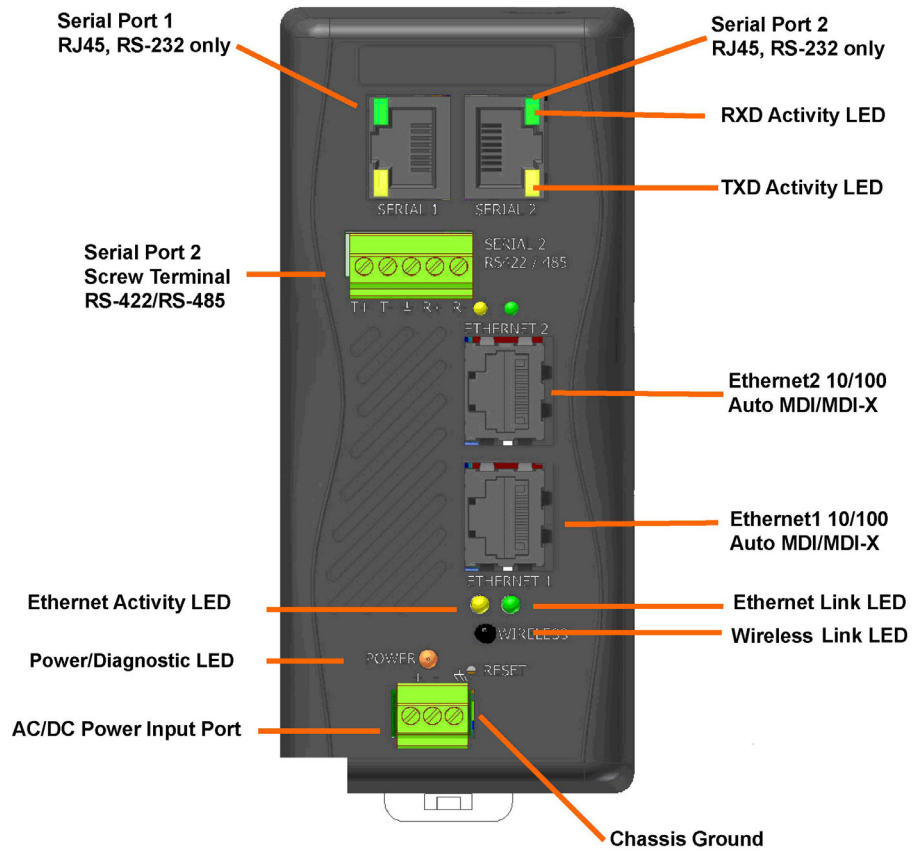

Serial Interface

The XPress DR+ supports RS-232 via RJ45 connectors. It also supports RS-422/485 via screw terminals (Serial Port 2 only).

Note: Serial Port 2 supports RS232, RS422, and RS485, but only one mode at a time. This means you can use either the RJ45 connector or the terminal block, not both.

The RJ45 serial connectors only support RS232, up to 230400 bits per second.

Table 3-1. RJ45 Serial Connector Pinouts

Pin	Direction	Name	Function
1	Output from DR+	RTS	Ready To Send
2	Output from DR+	DTR	Data Terminal Ready
3	Output from DR+	TXD	Transmitted Data
4	Ground	GND	Signal Ground
5	Ground	GND	Signal Ground
6	Input to DR+	RXD	Received Data
7	Input to DR+	DSR	Data Set Ready
8	Input to DR+	CTS	Clear To Send

Figure 3-3. RJ45 Connector – Front View

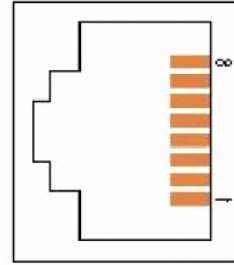

Screw Terminal Serial Connectors

Table 3-2. Serial Screw Terminal Pinout for RS422 (4-Wire)

Pin	Direction	Name	Function
1	Output	TX+	Transmit Data +
2	Output	TX-	Transmit Data -
3	Ground	GND	Signal Ground
4	Input	RX+	Received Data +
5	Input	RX-	Received Data -

Table 3-3. Serial Screw Terminal Pinout for RS485 (2-Wire)

Pin	Direction	Name	Function
1	Bi-directional	TX+/RX+	Transmit Data + and Received Data +
2	Bi-directional	TX-/RX-	Transmit Data - and Received Data -
3	Ground	GND	Signal Ground
4	Not Applicable	Not Applicable	Not Used
5	Not Applicable	Not Applicable	Not Used

Figure 3-4. Screw Terminal Ports

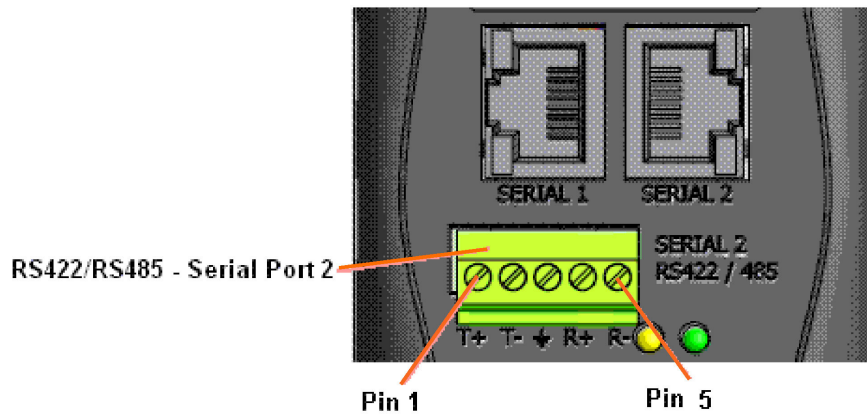

Note: Termination resistors ($R = 120 \text{ Ohm}$) are used to match impedance of a node to the impedance of the transmission (TX) line. Termination resistors should be placed only at the extreme ends of the data line, and no more than two terminations should be placed in any single segment of an RS-485 network. The termination resistors may not be needed for your application.

Figure 3-5. Termination Resistor for 2-Wire Connection

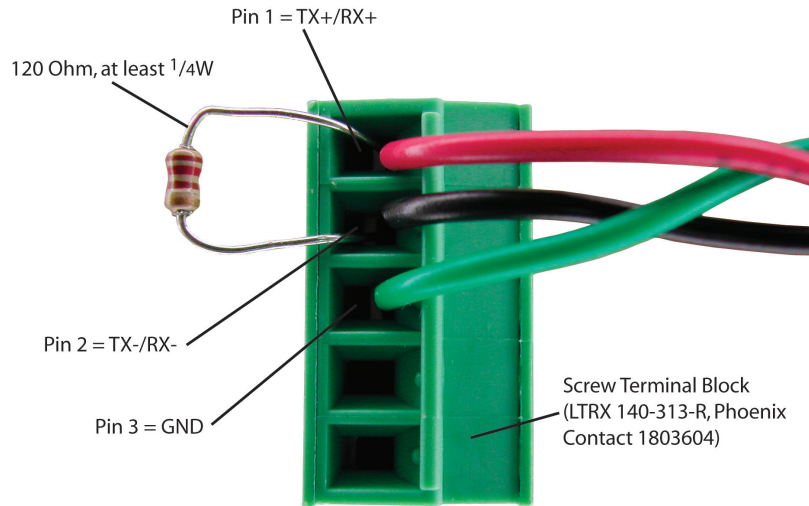

9-Pin RS-232 to Serial RJ45 Cable (P/N 500-103)

The included Lantronix (P/N 500-103) RJ45-DB9F serial cable assumes you are connecting a typical PC Com port to the XPress DR+ serial port. This cable is pinned to provide full serial line control to an RS232 DTE device. Lantronix offers a comprehensive list of cables and adapters to simplify device connectivity to the XPress DR+. See [Appendix B: Lantronix Cables and Adapters](#) for a full listing.

Figure 3-6. Lantronix P/N 500-103 RJ45-DB9F Serial Cable Pinout

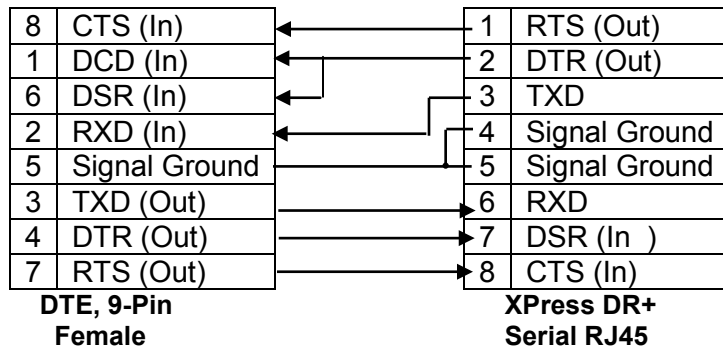

Ethernet Interface

The XPress DR+ includes a two-port unmanaged Ethernet switch with a future option to migrate to a managed solution.

The internal IEEE 802.3-compliant Ethernet switch is non-blocking, using a 1K MAC address lookup table with store-and-forward architecture. The XPress DR+ supports auto-negotiation for 10Base-T or 100Base-TX in full and half-duplex modes, as well as automatic MDI/MDIX crossover, allowing use of both straight-through and crossed Ethernet cables. The unit also supports IEEE 802.1d spanning tree, which protects against the possibility of a network loop.

Table 3-4. Ethernet Interface Signals

Pin	Direction	Name	Function
TX+	Out	1	Transmit Data +
TX-	Out	2	Transmit Data -
RX+	In	3	Differential Ethernet Receive Data +
RX-	In	6	Differential Ethernet Receive Data -

The next drawing shows a typical RJ45 connector. The color is not standard but very typical of an Ethernet patch cable. Pin 1 is located at the top of the connector (orange + white). The view is from the end of the connector.

Table 3-5. Typical RJ45 Connector

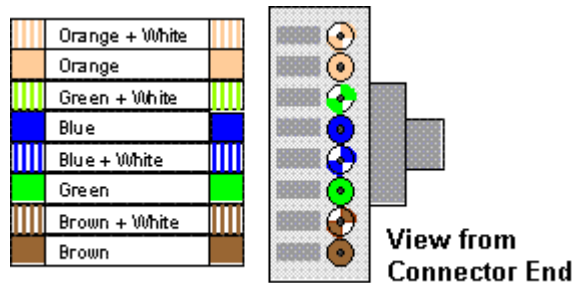

Multi-Drop Ethernet Connections

Although there are two Ethernet ports, the XPress DR+ only has one MAC address and IP address. Either port can be used as the primary connection with the other used to inter-connect other Ethernet devices or cascade from one XPress DR+ to another.

Figure 3-7. Multi-Drop Ethernet Connections

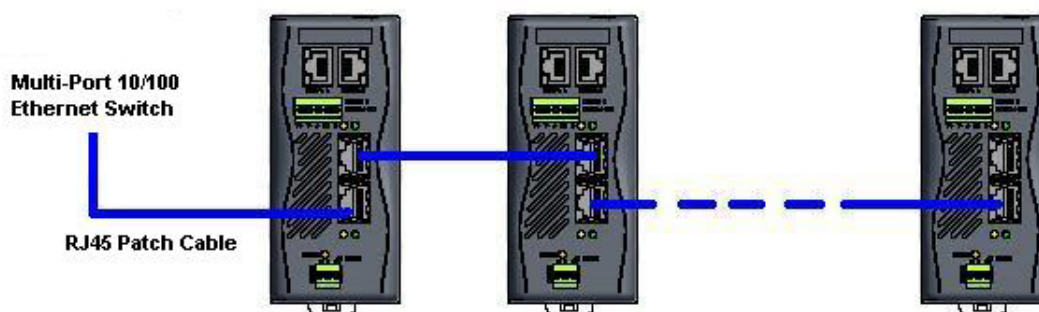

Power Requirements

As with most industrial automation devices, the XPress DR+ does not ship with a power supply. Its flexible power input circuit allows the product to be powered by any 9-30 VDC or 9-24 VAC power supply that can provide the 2.3-Watt maximum required by the XPress DR+.

In addition to the wide power input range, the XPress DR+ provides:

- ◆ 2K VAC and 2.8K VDC galvanic isolation between the power input and the Ethernet ports
- ◆ 2K VAC and 2.8K VDC galvanic isolation between the power input and the serial ports

Reset Switch

The XPress DR+ includes a hardware reset switch located in the small hole above the power connector. Pressing the reset switch causes a hardware reboot of the XPress DR+. The hardware reset does not reset or change the configuration of the XPress DR+.

Figure 3-8. Reset Switch

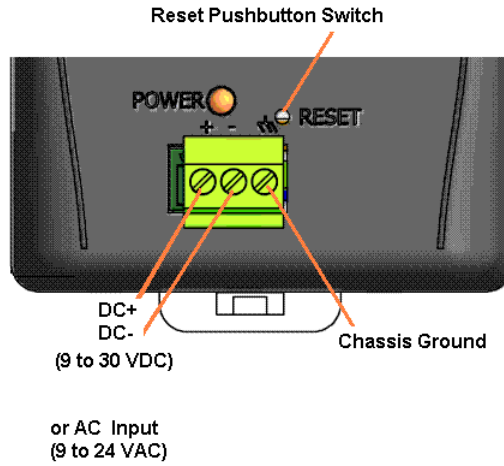

Caution: Even though a chassis ground is not required for operation, it is mandatory for protection against transient voltages and ESD. A chassis ground must be connected to earth.

LEDs

Note: For a description of the XPress DR+W's LEDs, see page 33.

Figure 3-9. LEDs on the XPress DR

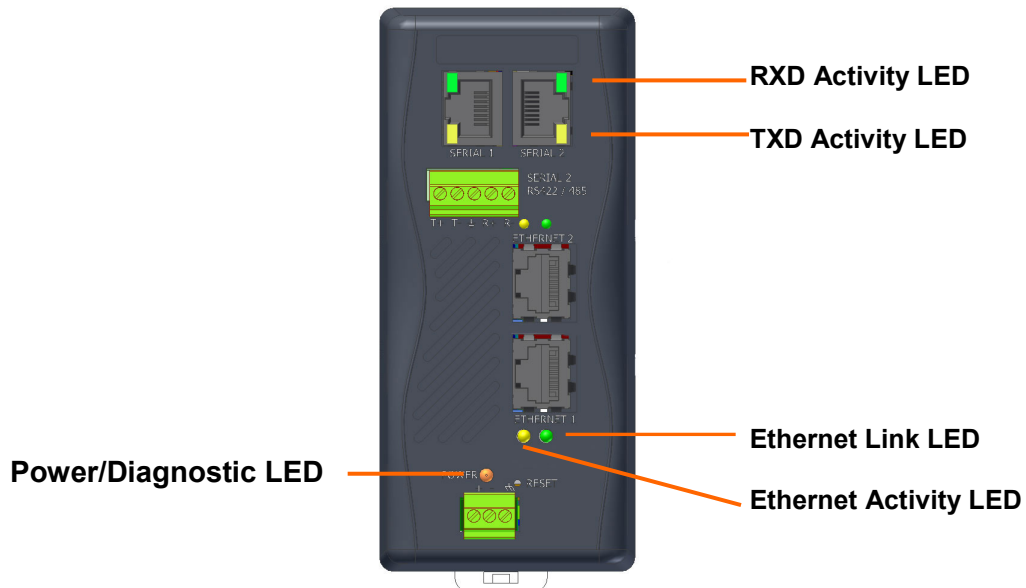

Table 3-6. XPress DR+ LED Functions

LED	Status	Meaning
Serial port - TXD LED (Yellow)	Off	No data being transmitted from XPress DR+
	Blinking	Data being transmitted from XPress DR+
Serial port - RXD LED (Green)	Off	No data being received by XPress DR+
	Blinking	Data being received by XPress DR+
Ethernet port - 10/100 Link (Green)	Off	No Ethernet link established
	Steady On	Ethernet link established
Ethernet port – Activity (Yellow)	Off	No data activity
	Blinking	Data activity
Power/Diagnostic LED (Orange)	Steady On	Power OK
	Blinking 2x	No DHCP response
	Blinking	Setup Menu active

Dimensions

The following drawing shows the dimensions of the XPress DR+

Figure 3-10. Dimensions

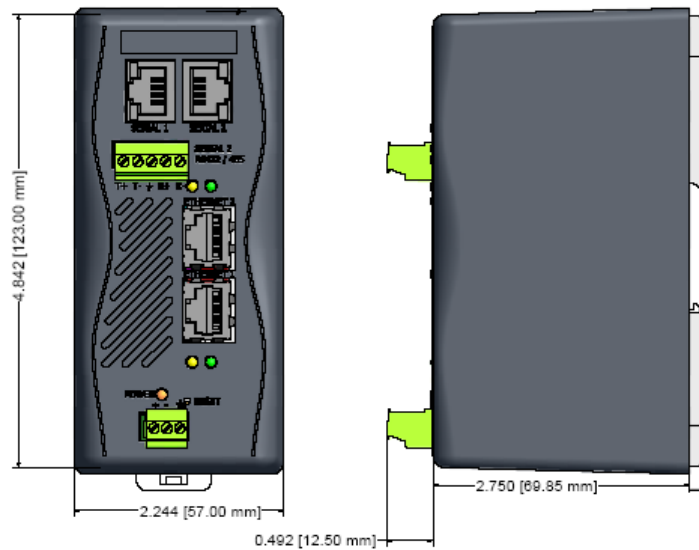

Wall Mount Bracket

Included with the XPress DR+ is an accessory DIN-rail wall mount bracket that makes it very easy to mount the unit in locations where a DIN-rail is not available.

Figure 3-11. Wall Mount Bracket

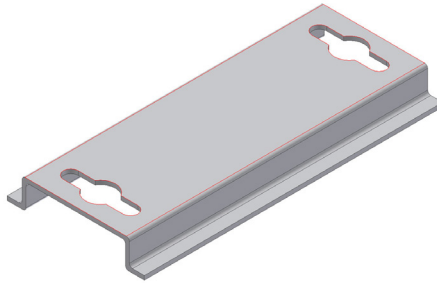

Product Information Label

The product information label on the underside of the unit contains important information about your specific unit:

- ◆ Bar code
- ◆ Serial number
- ◆ Product ID (name)
- ◆ Product description
- ◆ Hardware address (also referred to as Ethernet or MAC address)

Your unit will have one *similar* to the one below.

Figure 3-12. Product Label



Note: Before mounting the device on a DIN-rail, copy the information from the label.

Chapter 4: XPress DR+W

The wireless version of the XPress DR+ (XPress DR+W) provides serial-to-wireless network connectivity as an alternative to wired Ethernet connectivity. The wireless unit uses IP protocol (TCP for connection-oriented stream applications and UDP for datagram applications), enabling virtually any serial device or equipment to be remotely accessed, controlled, monitored, or shared on an 802.11b/g wireless network. The XPress DR+W provides a fully integrated solution that combines an operating system, embedded Web server, full TCP/IP protocol stack with an 802.11b/g transceiver supporting WEP and WPA security.

Application Examples

The XPress DR+W has an 802.11b/g transceiver in addition to its serial and Ethernet ports. Each serial port is connected to the serial communication port of a device. The wireless transceiver connects to another wireless device or to an Access Point (AP). This section includes typical scenarios for using the XPress DR+W.

Serial Tunneling – Network

Figure 4-1. Serial Tunneling Infrastructure Network Example

MARCOM IS FIXING

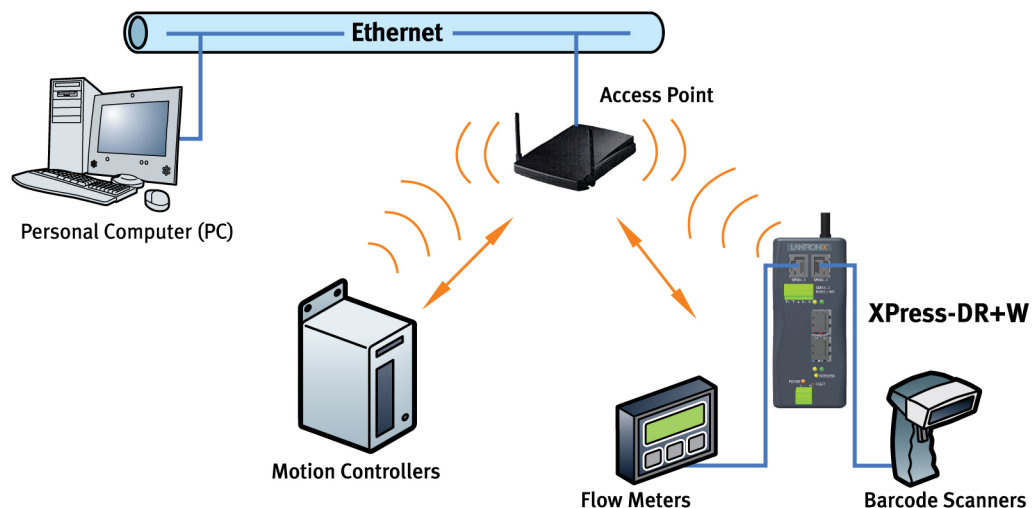

A PC connected to an AP via an Ethernet connection and a PC with a wireless connection to the AP LAN access the XPress DR+ W as though they are directly

connected to it. The combination of the XPress DR+W, a PC, and Lantronix's Com Port Redirector software allows the PC to communicate directly to the wireless unit's serial devices, providing wireless serial tunneling. Com Port Redirector is available for download at <https://www.lantronix.com/resources/product-index/>.

Ad Hoc Network

Figure 4-2. Ad Hoc Network Example

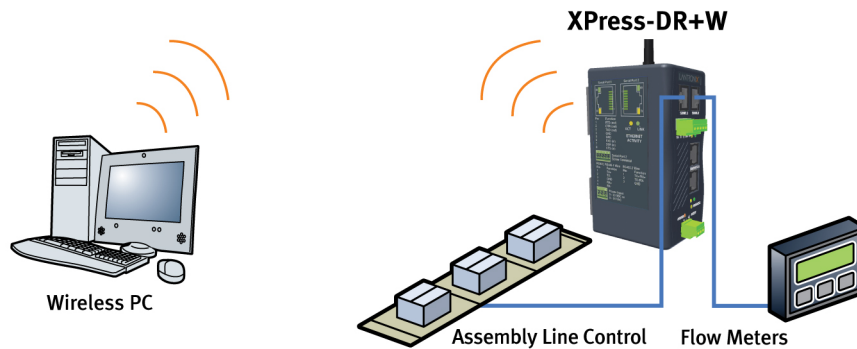

In the example above, the AP is not present. The PC makes a direct wireless connection with the XPress DR+W to manage serial devices. Without an AP, it is a peer-to-peer relationship.

Serial Tunneling – Infrastructure

Figure 4-3. Serial Tunneling Infrastructure Example

MARCOM IS FIXING

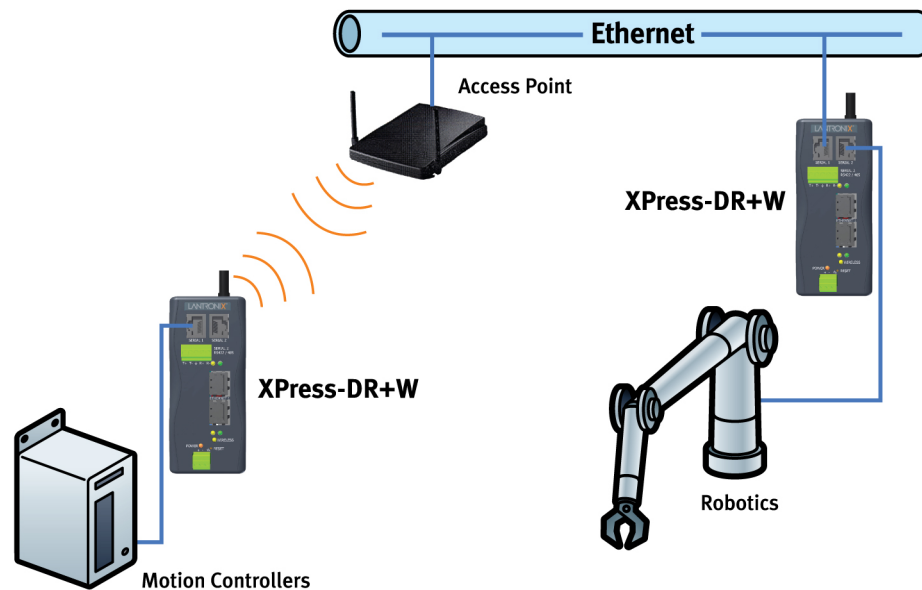

In the example above, the XPress DR+W communicates with another device server via the AP. The UDS device server, in this example, is connected via an Ethernet connection to the AP. In this way, the XPress DR+W and the device server communicate directly and can transfer information between their serial devices.

Ad Hoc XPress DR+W Connection

Figure 4-4. Direct XPress DR+W - to- XPress DR+W Connection

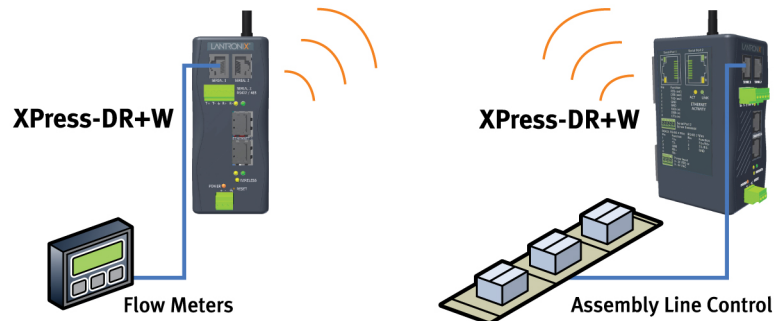

In the example above, two XPress DR+W s have established an Ad Hoc peer-to-peer relationship. They communicate directly to each other's serial devices without a PC or an AP.

Physically Connecting the XPress DR+W

Note: See page 34 for instructions on setting up the unit to configure it the first time.

To install the XPress DR+W:

1. Screw the antenna into the receptacle at the top of the XPress DR+.
2. Connect a serial device to your XPress DR+W. (See [Serial Interface](#) on page 21 for cable and connector specifications.)
3. Supply power to your XPress DR+ using a 9-30 VDC or 9-24 VAC (2.3W maximum) source. (See [Power Requirements](#) on page 25.)
4. Supply power to the serial device.

Figure 4-5. Typical XPress DR+W Configuration

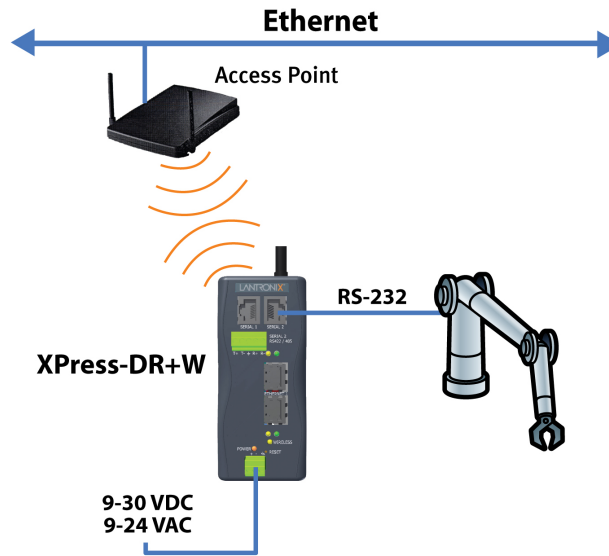

Front Panel Description

The following figure illustrates the screw block connector pinouts and other components of the XPress DR+W.

Figure 4-6. XPress DR+W Front Panel Layout

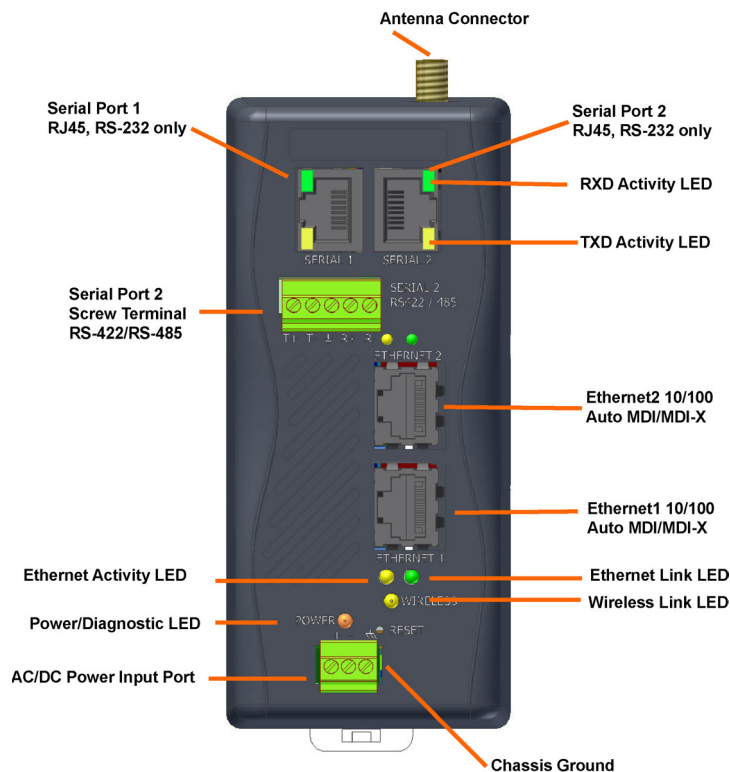

LEDs

Table 4-1. XPress DR+W LED Functions

LED	Status	Meaning
Serial port - TXD LED (Yellow)	Off	No data being transmitted from XPress DR+
	Blinking	Data being transmitted from XPress DR+
Serial port - RXD LED (Green)	Off	No data being received by XPress DR+
	Blinking	Data being received by XPress DR+
Ethernet port - 10/100 Link (Green)	Off	No Ethernet link established.
	Steady On	Ethernet link established.
Ethernet port – Activity (Yellow)	Off	No data activity
	Blinking	Data activity
Power/Diagnostic LED (Orange)	Steady On	Power OK
	Blinking 2x	No DHCP response
	Blinking 2x	Setup Menu active
Wireless LED (Yellow)	Off	Wireless off (not configured for wireless)
	Off	Wireless on, searching
	Blinking (very short)	Wireless on, attempting to associate
	On	Wireless on, associated, power management off
	On when receiving or transmitting, off in-between	Wireless on, associated, power management on

Required Information for Initial Configuration

Hardware Address

Take note of the unit's hardware address (also known as MAC address). It is on the product label, in the format: 00-20-4a-XX-XX-XX, where the XXs are unique numbers assigned to the product.

Hardware Address: 00-20-4a-____ - ____ - ____

IP Address

The XPress DR+W must have a unique IP address on the network. The systems administrator generally provides the IP address, subnet mask, and gateway.

IP Address: _____

Subnet Mask: _____

Gateway: _____

WLAN Settings

Before the XPress DR+W can communicate on an 802.11b/g wireless network, the WLAN settings must match the wireless network. By default, the XPress DR+W is set to Ad Hoc network mode, and its wireless Network Name (SSID) is **LTRX_IBSS**.

You can configure WEP, WPA, or WPA2/802.11i settings:

Note: WPA and WPA2/802.11i security are only available in infrastructure mode.

Installing the XPress DR+W for Initial Configuration

Two settings are required for the XPress DR+W to communicate on a wireless network:

- ♦ The Server (0) settings
- ♦ The WLAN (4) settings

Complete the following steps to connect and initially configure the XPress DR+W required settings. Initial configuration is done using the Setup Mode's Change Setup menu.

1. Connect one end of the supplied serial cable to the unit's serial port 1. (See [9-Pin RS-232 to Serial RJ45 Cable \(P/N 500-103\)](#) on page 23.)
2. Connect the other end of the serial cable to a terminal or a PC's serial COM port.
3. On the PC, open a terminal emulation application (e.g. HyperTerminal). Configure the XPress DR+W serial settings as 9600 baud, 8 bits, not parity, 1 stop bit, and no flow control (9600, 8, N, 1).
4. Enter Setup Mode by simultaneously connecting the power supply and holding down the **x** key. Upon connection, the following information displays:

```
*** Lantronix XPress DR+ Wireless IA Device Server ***
MAC address 00204A2311B2
Software version V6.3.0.1T2 <060826>

Press Enter for Setup Mode

Model: Device Server Plus+! <Firmware Code:IA>
```

5. Press **Enter** within 5 seconds to display the **Change Setup** menu.

Server Configuration (Option 0)

You can configure the unit's basic network parameters when you select **Server configuration** (option 0).

Note: Current values display in parentheses.

Network Mode (XPress DR+W only)

The first prompt requires you to set the unit for wired or wireless use. Wireless is the default, so just press **Enter** at the prompt.

Figure 4-7. Network Mode

```
Network mode: 0=Wired Only, 1=Wireless Only <0> ? _
```

The **IP Address**, **Set Gateway IP Address**, and **Netmask** fields display the current values.

Figure 4-8. Server Settings

```
IP Address : (000) . (000) . (000) . (000)
Set Gateway IP Address (N)
Netmask: Number of Bits for Host Part (0=default) (0)
Change telnet config password (N)
```

IP Address

If DHCP is not used to assign IP addresses, enter the IP address manually. The IP address must be set to a unique value in the network. Enter each octet and press **Enter** between each section. The current value displays in parentheses.

```
IP Address : (000) (000) (000) (000) _
```

If DHCP is used, the third octet of the IP address sets the BootP/DHCP/AutoIP options. The following table shows the bits you can manually configure to force the XPress DR+ to disable AutoIP, DHCP, or BootP. To disable an option, set the appropriate bit.

Table 4-2. BootP/DHCP/AutoIP options

Options	Bit	Value
AutoIP	0	1
DHCP	1	2
BootP	2	4

For example, if the third octet is 0.0.5.0, the AutoIP and BootP options are disabled; only DHCP is enabled. (The value 5 results from adding the binary equivalents of 0 and 2.) This is the most common setting when using DHCP.

Set Gateway IP Address

The gateway address, or router, allows communication to other LAN segments. The gateway address should be the IP address of the router connected to the same LAN segment as the unit. The gateway address must be within the local network. The default setting is **N** (No), meaning the gateway address has not been set. To set the gateway address, type **Y** and enter the address.

```
Set Gateway IP Address (N) ? Y
Gateway IP addr (000) (000) (000) (000) _
```

Netmask: Number of Bits for Host Part

A netmask defines the number of bits taken from the IP address that are assigned for the host part.

```
Netmask: Number of Bits for Host Part (0=default) (0) _
```

Note: Class A: 24 bits; Class B: 16 bits; Class C: 8 bits

The unit prompts for the number of host bits to be entered, then calculates the netmask, which appears in standard decimal-dot notation (for example, 255.255.255.0) when the saved parameters display.

Table 4-3. Standard IP Network Netmasks

Network Class	Host Bits	Netmask
A	24	255.0.0.0
B	16	255.255.0.0
C	8	255.255.255.0

Change Telnet/Web Manager Password

Setting the Telnet configuration password prevents unauthorized access to Setup Mode through a Telnet connection to port 9999 or through web pages.

Please protect your device from unauthorized access and follow the instructions below:

- ◆ Always select **Y** to enable Telnet/Web Manager password
- ◆ Enable the enhanced password setting and create a strong 16-character password. For details, see [Security Settings \(Option 6\)](#) on page 90.

Note: We do not recommend that you only use the 4-character basic password as it does not offer sufficient security. Using no password is very dangerous.

```
Change Telnet/Web Manager password (N) ? _
```

Change DHCP Device Name:

Change the DHCP name if the network is DHCP-enabled.

```
Change DHCP device name (not set) ? (N) N
Enter new DHCP device name :
```

WLAN Configuration (Option 4)

Without adequate protection, a wireless LAN is susceptible to access by unauthorized users. For that reason, XPress DR+W features the WPA security standard, based on IEEE802.11i. WEP is provided for backwards compatibility and interaction with older devices.

Note: Due to regulations, the country-specific setting has been removed from the setup menu and Web Manager. We provide a separate utility for changing the **Country/Zone** setting. The utility is called **SetZone** and is included in the XPress DR+W package. It is also available for download from the Lantronix web site.

The syntax is **SetZone <IP address> [<zone abbreviation>]**

Leaving the zone blank causes the utility to report the current setting only. Following are valid zone abbreviations. These settings are consistent with IEEE802.11b/g zones:

US=United States	JP=Japan
CA=Canada	OT=Others, such as Europe
FR=France	(excluding France), Asia, Africa, and
SP=Spain	Australia

To modify WLAN settings, select **4 WLAN** from the Change Setup menu.

Topology

Select **Infrastructure** (ESS) mode or **Adhoc** (IBSS) mode. Infrastructure mode communicates with Access Points. Ad Hoc mode communicates only with other clients.

```
Topology 0=Infrastructure, 1=Adhoc (1) ? _
```

Network Name (SSID)

Enter the name of the network to which the XPress DR+W will connect.

```
Network name (LTRX_IBSS) ? _
```

Adhoc Network Channel

When **Adhoc** is selected in the **Topology** parameter, and the XPress DR+W cannot find the specified network, it creates one with that name by transmitting a beacon on the selected channel.

```
Channel (11) ? _
```

Only channels allowed in the country for which the XPress DR+W is designated can be selected. The country displays in the Setup Mode settings overview.

Security

The **Security Suite** prompt enables you to select the type of security. The XPress DR+W features WEP, WPA and WPA2/802.11i to secure all wireless communication. WPA and WPA2/802.11i are only available when the topology is **Infrastructure**.

```
Security suite: 0=none, 1=WEP, 2=WPA, 3=WPA2/802.11i (0) ?
```

Notes:

- ◆ In the WPA and WPA2 modes, the encryption setting denotes the lowest acceptable encryption method, CCMP > TKIP > WEP. For example, if the unit is configured for WEP, and the Access Point supports TKIP, the negotiation will result in TKIP being used. If the unit is configured for TKIP, and the Access Point only supports WEP, association will fail because the Access Point does not meet the unit's demands. (CCMP is only available in WPA2 mode.)
- ◆ Communication between the Access Point and a single wireless device is called unicast and uses the pairwise encryption method. Communication from the Access Point to many wireless devices at once is called multicast and uses the group encryption method.

*To receive broadcast and multicast messages, the group encryption for all wireless devices communicating with the same access point must be equal. If any of these devices is WEP-only (no support for WPA), set the encryption to **TKIP+WEP**.*

A group encryption lower than the pairwise encryption is necessary to use higher security with the XPress DR+W than other devices connecting to the same Access Point can support.

- ◆ CCMP is also called AES on products of other manufacturers. CCMP is an extension of AES. It provides the strongest current encryption method.

WEP

```
Topology: 0=Infrastructure, 1=Ad-Hoc (1) ? 1
Network name (SSID) (LTRX_IBSS) ?
Channel (11) ?
Security suite: 0=none, 1=WEP (0) ? 1
Authentication: 0=open/none, 1=shared (0) ?
Encryption: 1=WEP64, 2=WEP128 (1) ?
Display current key (N) ?
Change Key (N) ? Y
Key type 0=hex, 1=passphrase (0) ?
Enter Key: **-*-*-*-*-*
TX Key index (1) ?
```

Authentication selects whether the encryption keys are matched (1 = shared) with those of the communication partner before passing through messages or not (2 = open/none).

The **Encryption** prompt requests the length of the encryption key and the security strength. WEP64 uses a 40 bits/5 bytes key (option 1). WPE128 uses a 104 bits/13 bytes key (option 2).

Select **Y** (Yes) at the **Display current key** prompt to show the currently configured key/passphrase.

Select **Y** (Yes) at the **Change key** prompt to be able to modify the currently configured key.

The **Key type** indicates whether the new key is in hexadecimal or passphrase format.

Enter key prompts for the new encryption key.

Key Type	Encryption Key
Hex	Enter the Encryption Key as a hexadecimal value according the following guidelines: <ul style="list-style-type: none"> ◆ Valid Hex alphanumeric characters are 0-9 and A-F. ◆ 64 bit hex = 5 bytes represented as xx-xx-xx-xx-xx. Example: 01-A3-47-E5-C9 ◆ 128 bit hex = 13 bytes represented as xx-xx-xx-xx-xx-xx-xx-xx-xx-xx-xx-xx-xx. Example: A1-B2-C3-E4-D5-F6-98-74-B7-65-A8-D3-F2
Passphrase	Enter the key as a string. A passphrase is a sentence that is translated into hex by a hashing algorithm. Example: My dog has spots and likes to chase cats. A passphrase of more than 20 characters is recommended. Maximum length is 63 characters. Spaces and punctuation characters are permitted. Passphrase input is not the same as ASCII input. The passphrase input is safer because it has up to 63 characters. ASCII input has a maximum of 5 (WEP64) or 13 (WEP128) characters and limits the number of key combinations.

TX Key index selects the WEP key used for transmissions. Enter a value between 1 and 4. The default setting is 1. In case the WEP key is entered in hex, all keys (1-4) are the same. In case the WEP key is entered as a passphrase, the four WEP keys are generated according to the Linksys algorithms and will be different.

WPA

This firmware version allows only **Pre-Shared Keys (PSK)** for authentication.

```

Topology: 0=Infrastructure, 1=Ad-Hoc <1> ? 0
Network name (SSID) <LTRX_IBSS> ?
Security suite: 0=none, 1=WEP, 2=WPA, 3=WPA2/802.11i <1> ? 2
Display current key <N> ?
Change Key <N> ? Y
Key type 0=hex, 1=passphrase <0> ?
Enter Key: **-*-*-*-*-*-*-*-*-*-*-*-*-*-*-*-*-*-*-*-*-*-*-*-*-*-*-*-*-*-*-*-*-*-*
**-*-*-*-*-*-*-*-*-*-*
Encryption: 0=TKIP, 1=TKIP+WEP <1> ?
TX Data rate: 0=fixed, 1=auto fallback <1> ?
TX Data rate: 0=1, 1=2, 2=5.5, 3=11, 4=18, 5=24, 6=36, 7=54 Mbps <7> ?
Enable power management <N> ?

```

Select **Y** (Yes) at the **Display current key** prompt to show the currently configured key/passphrase,

Select **Y** (Yes) at the **Change key** prompt to be able to modify the currently configured key by selecting **Y** (Yes).

The **Key type** requests whether the new key is in hexadecimal or passphrase format. The default setting is **Passphrase**.

Enter key prompts for the new passphrase or hexadecimal key.

Key Type	Encryption Key
Hex	<p>Enter the Encryption Key as a hexadecimal value according the following guidelines:</p> <ul style="list-style-type: none"> ◆ Valid Hex alphanumeric characters are 0-9 and A-F. ◆ 64 bit hex = 5 bytes represented as xx-xx-xx-xx-xx. Example: 01-A3-47-E5-C9 ◆ 128 bit hex = 13 bytes represented as xx-xx-xx-xx-xx-xx-xx-xx-xx-xx-xx-xx-xx. Example: A1-B2-C3-E4-D5-F6-98-74-B7-65-A8-D3-F2
Passphrase	<p>Enter the key as a string. A passphrase is a sentence that is translated into hex by a hashing algorithm. Example: My dog has spots and likes to chase cats.</p> <p>A passphrase of more than 20 characters is recommended. Maximum length is 63 characters, including spaces and punctuation characters.</p> <p>Passphrase input is not the same as ASCII input. The passphrase input is safer because it has up to 63 characters. ASCII input has a maximum of 5 (WEP64) or 13 (WEP128) characters and limits the number of key combinations.</p> <p>Please refer to the other equipment's manual to determine the passphrase input style recommended.</p>

Set the **Encryption** type to the minimum required security. The plus sign denotes that the group (broadcast) encryption method is different from the pairwise (unicast) encryption, in this case WEP and TKIP, respectively. For example, CCMP+TKIP => pairwise = CCMP, and group = TKIP.

WPA2/802.11i

The WPA2/802.11i mode complies with the Robust Secure Network specified in the IEEE standard 802.11i. It enables the AES-based strong CCMP encryption.

```

Topology: 0=Infrastructure, 1=Ad-Hoc <0> ? 0
Network name <SSID> <LTRX_IBSS> ?
Security suite: 0=none, 1=WEP, 2=WPA, 3=WPA2/802.11i <2> ? 3
Display current key <N> ?
Change Key <N> ? Y
Key type 0=hex, 1=passphrase <0> ? 1
Enter Key: *****
Encryption: 0=CCMP, 1=CCMP+TKIP, 2=CCMP+WEP, 3=TKIP, 4=TKIP+WEP <3> ?

```

Enter key prompts for the new passphrase. Maximum length is 63 characters; the recommended minimum is 20 characters.

Set the **Encryption** type to minimum required security. The plus sign denotes that the group (broadcast) encryption method is different from the pairwise (unicast) encryption. For example CCMP+TKIP => pairwise = CCMP, and group = TKIP.

Fixed or Automatic Data Rate

The XPress DR+W can control the transmission rate. Select **0** to set a fixed data rate, or select **1** to set an automatic data rate. The default setting is **1** (auto).

```
TX Data rate 0=fixed, 1=auto (1) ? _
```

Transmission Data Rate

If the above **TX Data rate** is set to **fixed**, the selected data rate is the XPress DR+W's fixed transmission rate. If the above **TX Data rate** is set to **auto**, the selected data rate is the XPress DR+W's maximum data rate. Lower data rates allow for larger distances. They may also be required when communicating with older devices. The default setting is **11 Mbps**.

```
TX Data rate 0=1, 1=2, 2=5.5, 3=11
              4=18, 5=24, 6=36, 7=54 Mbps (0) ? _
```

Note: The unit's maximum data rate cannot be selected when **TX Data rate** is set to **auto**.

Next Steps

1. Upon completing the IP and WLAN settings, select menu option **9** to save and exit the XPress DR+W Setup Mode.
2. To configure the XPress DR+W further, continue to Chapter 6: Configuration Using Web Manager or Chapter 7: Configuration Using Telnet or Serial Port (Setup Mode).

Chapter 5: Using DeviceInstaller

This chapter covers the steps for getting the XPress DR+ device server online and viewing its current configuration.

Note: For the latest firmware, release notes, and user documentation, go to the Lantronix web site (www.lantronix.com).

Installing DeviceInstaller

To install DeviceInstaller:

1. Download the latest version of the DeviceInstaller utility from <http://www.lantronix.com/downloads>.
2. Run the executable to start the installation process.
3. Respond to the installation wizard prompts. (If prompted to select an installation type, select **Typical**).

Assigning an IP Address

Note: To use DeviceInstaller for communication to an XPress DR+W over a wireless network, you must first configure the network and WLAN settings using a serial connection.

The XPress DR+'s IP address must be configured before the unit can work correctly on a network. You have several options for assigning an IP to your unit. We recommend that you manually assign the IP address over the network using DeviceInstaller software, which is on the product CD.

The unit's IP address is normally set to 0.0.0.0 at the factory. The hardware address is on the product label. The unit is DHCP-enabled as the default.

To assign an IP address manually:

1. Click **Start**→**Programs** → **Lantronix**→**DeviceInstaller 4.4** →**DeviceInstaller**. If your PC has more than one network adapter, a message displays. Select an adapter and click **OK**.

Note: If the unit already has an IP address (e.g., DHCP has assigned an IP address), click the **Search** icon and select the unit from the list of Lantronix device servers on the local network.

2. Click the **Assign IP** icon .
3. If prompted, enter the hardware address (on the product label) and click **Next**.

4. Select **Assign a specific IP address** and click **Next**.
5. Enter the **IP address**. The **Subnet mask** displays automatically based on the IP address; if desired, you may change it. On a local network, you can leave the **Default gateway** blank (all zeros). Click **Next**.
6. Click the **Assign** button and wait several seconds until a confirmation message displays. Click **Finish**.
7. Select the device from the main window list and select **Ping** from the **Tools** menu. The Ping Device dialog box shows the IP address of the selected unit.
8. Click the **Ping** button. The results display in the Status window. Click the **Clear Status** button to clear the window so you can ping the device again.

***Note:** If you do not receive “Reply” messages, make sure the unit is properly attached to the network and that the IP address assigned is valid for the particular network segment you are working with. If you are not sure, check with your systems administrator.*
9. Click the **Close** button to close the dialog box and return to the main window.

Accessing the XPress DR+ Using DeviceInstaller

1. Click **Start**→**Programs** → **Lantronix**→**DeviceInstaller 4.4** →**DeviceInstaller**.
2. Click the **Search** icon  to display all Lantronix units on the network.
3. Click the **XPress DR+** folder. The list of available Lantronix XPress DR+ devices displays.
4. Expand the list of XPress DR+ devices by clicking the **+** symbol next to the XPress DR+ icon. To view the unit's current configuration, select the unit by clicking its IP address.

Viewing the Current Configuration

DeviceInstaller provides a view of the unit's configuration.

To view the unit's current settings:

1. Follow the instructions above to locate the XPress DR+.
2. In the right pane, click the **Device Details** tab. The current XPress DR+ configuration displays.

Table 5-1. Viewing Current Settings

Setting	Description
Name	Configurable field. A name that identifies the XPress DR+. Double-click the field, type in the value, and press Enter to complete. This name is not visible on other PCs or laptops using DeviceInstaller.

Setting	Description
Group	Configurable field. A group name to categorize the XPress DR+. Double-click the field, type in the value, and press Enter to complete. This group name is not visible on other PCs or laptops using DeviceInstaller.
Comments	Configurable field. Information about the XPress DR+. Double-click the field, type in the value, and press Enter to complete. This description or comment is not visible on other PCs or laptops using DeviceInstaller.
Device Family	Non-configurable field. Displays the unit's device family type as XPress .
Type	Non-configurable field. Displays the device type as XPress DR+ .
ID	Non-configurable field. Displays the unit's ID embedded within the box.
Hardware Address	Non-configurable field. Displays the unit's hardware (or MAC) address.
Firmware Version	Non-configurable field. Displays the firmware currently installed on the XPress DR+.
Extended Firmware Version	Non-configurable field. Displays the full version nomenclature of the firmware.
Online Status	Non-configurable field. Displays the unit's status as online, offline, unreachable (the XPress DR+ is on a different subnet), or busy (the XPress DR+ is currently performing a task).
Telnet Enabled	Non-configurable field. Displays True . Permits Telnet sessions.
Telnet Port	Non-configurable field. Displays the unit's port for telnet sessions.
Web Enabled	Non-configurable field. Displays True . Permits configuration through Web Manager.
Web Port	Non-configurable field. Displays the unit's port for Web Manager configuration.
Maximum Baud Rate Supported	Non-configurable field. Displays the unit's maximum baud rate. Note: <i>The XPress DR+ may not be running at this rate currently.</i>
Firmware Upgradeable	Non-configurable field. Displays True , indicating the unit's firmware is upgradeable as newer versions become available.
IP Address	Non-configurable field. Displays the unit's current IP address. To change the IP address, see Assigning an IP Address on page 42.
Number of COB partitions supported	Non-configurable field. Displays the number of COB partitions supported.
Supports Dynamic IP	Non-configurable field. Indicates whether the current IP address on the XPress DR+ was set manually or assigned automatically.
DHCP	Non-configurable field that displays only if the unit supports Dynamic IP. True indicates that the IP address can be assigned automatically by DHCP.

Setting	Description
BOOTP	Non-configurable field that displays only if the unit supports Dynamic IP. True indicates that the IP address can be assigned automatically by BOOTP.
RARP	Non-configurable field that displays only if the unit supports Dynamic IP. True indicates that the IP address can be assigned automatically by RARP.
Subnet Mask	Non-configurable field. Displays the unit's current subnet mask. To change the subnet mask, see Assigning an IP Address on page 42.
Gateway	Non-configurable field. Displays the unit's current gateway. To change the gateway, see Assigning an IP Address on page 42.
Number of Ports	Non-configurable field. Displays the number of ports on the XPress DR+.
TCP Keepalive	Non-configurable field. Displays the unit's TCP keepalive value. The value is in the range 1-65s, and the default setting is 45 .
Supports Configurable Pins	Non-configurable field. Displays False , indicating configurable pins are not available on the XPress DR+.
Supports Email Triggers	Non-configurable field. Displays False .
Supports AES Data Stream	Non-configurable field. Displays False .
Supports 485	Non-configurable field. Displays True . XPress DR+ supports the RS-485 protocol.
Supports 920K Baudrate	Non-configurable field. Displays False . XPress DR+ supports baud rates up to a maximum of 230 Kbaud.
Supports HTTP Server	Non-configurable field. Displays True .
Supports HTTP Setup	Non-configurable field. Displays True .
Supports 230K Baud Rate	Non-configurable field. XPress DR+ supports a baud rate of 230 Kbaud. Displays True .
Supports GPIO	Non-configurable field. Displays False .

Chapter 6: Configuration Using Web Manager

You must configure the unit so that it can communicate on a network with your serial device. For example, you must set the way the unit will respond to serial and network traffic, how it will handle serial packets, and when to start or close a connection.

The unit's configuration is stored in nonvolatile memory and is retained without power. You can change the configuration at any time. The unit performs a reset after you change and store the configuration.

In this chapter, we describe how to configure the XPress DR+ using Web Manager, Lantronix's browser-based configuration tool. Web Manager refers to our web-based configuration manager for the device server product. (For information on using Setup Mode, our command line configuration interface, see [Chapter 7: Configuration Using Telnet or Serial Port \(Setup Mode\)](#).)

Notes:

- ◆ The examples in this section show a typical device. Your device may have different configuration options.
- ◆ For the latest firmware, release notes, and user documentation, go to www.lantronix.com.
- ◆ To use Web Manager for communication to an XPress DR+W over a wireless network, you must first configure the network and WLAN settings using a serial connection. See [Chapter 4: XPress DR+W](#)

Installing the DeviceInstaller Utility

To install the DeviceInstaller Utility:

1. Download the latest version of the DeviceInstaller utility from <http://www.lantronix.com/downloads>.
2. Run the executable to start the installation process.
3. Respond to the installation wizard prompts. (If prompted to select an installation type, select Typical).

Accessing XPress DR+ Using DeviceInstaller

Note: Make note of the hardware (MAC) address. You will need it to locate the XPress DR+ using DeviceInstaller. (For more information on the hardware address, see [Hardware Address](#) on page 17.)

4. Click **Start**→**Programs** → **Lantronix**→**DeviceInstaller 4.4** →**DeviceInstaller**. If the PC has more than one network adapter, a message displays requesting the selection of a network adapter. Select an adapter and click **OK**.

5. Click the **Search** icon . The list of Lantronix device servers displays in the left pane.
6. Click on the **XPress DR+** folder. The list of available XPress DR+ units displays.
7. Expand the list of XPress DR+ units by clicking the **+** symbol next to the XPress DR+ icon.
8. Select the XPress DR+ unit by clicking its hardware address.
9. In the right pane, click the **Web Configuration** tab.
10. To view the unit's Web Manager in the current DeviceInstaller window, click the **Go** button.

OR

To open the Web Manager in a web browser, click the **External Browser** button. The Web Manager displays.

Note: *Alternatively, to open Web Manager, start your web browser and enter the IP address of the XPress DR+.*

A dialog box appears to prompt for a **User name** and **Password**.

11. Perform one of the following:
 - ♦ If no Telnet/Web Manager password has been defined, leave both fields blank and click **OK**.
 - ♦ If a Telnet/Web Manager password has been defined, leave the username blank, type in the password, and then click **OK**.

The Web-Manager displays.

Note: *We recommend that you always use the enhanced password setting and create a strong 16 character password. See [Security Settings \(Option 6\)](#) on page 90.*

Figure 6-1. Lantronix Web Manager



The main menu is in the left pane of the Web Manager window.

Note: The WLAN option applies only to the XPress DR+W.

Network Configuration

The unit's network values display when you select **Network** from the main menu. The following sections describe the configurable parameters on the Network Settings page.

Figure 6-2. Network Settings

Automatic IP Address Configuration

An IP address can be assigned automatically. You then enter related network settings.

To assign an IP address automatically:

1. On the main menu, click **Network**.
2. **(Wireless units only)** From the **Network Mode** drop-down list, select **Wired Only** or **Wireless Only** to set the unit for wired or wireless use.
3. Select **Obtain IP address automatically**.
4. Enter the following (as necessary):

BOOTP	Select Enable to permit the Bootstrap Protocol (BOOTP) server to assign the IP address from a pool of addresses automatically. Enable is the default setting.
--------------	---

DHCP	Select Enable to permit the Dynamic Host Configuration Protocol (DHCP) to assign a leased IP address to the XPress DR+ unit automatically. Enable is the default setting.
AutoIP	Select Enable to permit the XPress DR+ to generate an IP in the 169.254.x.x address range with a Class B subnet. Enable is the default setting.
DHCP Host Name	Enter the name of the host on the network providing the IP address.

Note: Disabling BOOTP, DHCP, and AutoIP (all three checkboxes) is not advised as the only available IP assignment method will then be ARP or the serial port.

- When finished, click the **OK** button.
- To save and reboot, click **Apply Settings** on the main menu.

Static IP Address Configuration

You manually assign an IP address to the unit and enter related network settings.

To assign an IP address manually:

- On the main menu, click **Network**.
- (Wireless units only)** From the **Network Mode** drop-down list, select **Wired Only** or **Wireless Only** to set the unit for wired or wireless use.
- Select **Use the following IP configuration**.
- Enter the following (as necessary):

IP Address	Enter the IP address manually in decimal-dot notation. The IP address must be set to a unique value in the network.
Subnet Mask	A subnet mask defines the number of bits taken from the IP address that are assigned for the host part.
Default Gateway	The gateway address, or router, allows communication to other LAN segments. The gateway address should be the IP address of the router connected to the same LAN segment as the unit. The gateway address must be within the local network.

- When finished, click the **OK** button.
- To save and reboot, click **Apply Settings** on the main menu.

Server Configuration

The unit's server values display when you select **Server** from the main menu. The following sections describe the configurable parameters on the Server Settings page.

Figure 6-3. Server Settings

To configure the unit's device server settings:

1. On the main menu, click **Server**.
2. Configure or modify the following fields:

Server Configuration

<p>Enhanced Password</p> <p><i>Note: We recommend that you always enable the enhanced password setting, and create a strong 16 character password.</i></p>	<p>Select whether to enable enhanced password:</p> <ul style="list-style-type: none"> ♦ Enable: selecting this option enables advanced password creation, allowing you to create passwords up to 16 bytes in length. ♦ Disable: selecting this option disables advanced password creation, allowing you to create basic passwords up to 4 bytes in length.
<p>Telnet/Web Manager Password</p>	<p>Enter the password required for Telnet configuration and Web Manager access.</p>
<p>Retype Password</p>	<p>Re-enter the password required for Telnet configuration and Web Manager access.</p>

Advanced

<p>ARP Cache Timeout</p>	<p>When the unit communicates with another device on the network, it adds an entry into its ARP table. ARP Cache timeout defines the number of seconds (1-600) before it refreshes this table.</p>
---------------------------------	---

TCP Keepalive	Defines how many seconds the unit waits during an inactive connection before checking its status. If the unit does not receive a response, it drops that connection. Enter a value between 0 and 65 seconds. 0 disables keepalive. The default setting is 45 .
Monitor Mode @ Bootup	Select Disable to disable entry into the monitor mode using the yyy or xx1 key sequence at startup. This field prevents the unit from entering monitor mode by interpreting the stream of characters that are received during the device server's initialization at startup.
HTTP Server Port	This option allows the configuration of the web server port number. The valid range is 1-65535. The default setting is 80 .
Config Server Port	This option allows the configuration of the Config Server Port. Default setting is 30718.
MTU Size	The Maximum Transmission Unit (MTU) is the largest physical packet size a network can transmit for TCP and UDP. Enter between 512 and 1400 bytes. The default setting is 1400 bytes.
TCP Re-transmission timeout (ms)	The desired TCP re-transmission timeout value. If the ACK is not received for a packet sent from the XPress DR+ device server, then the unit will retransmit the data. The valid range is 500-4000 msec.

- When you are finished, click the **OK** button.
- To save and reboot, on the main menu, click **Apply Settings**.

Host List Configuration

The XPress DR+ scrolls through the host list until it connects to a device listed in the host list table. After a successful connection, the unit stops trying to connect to any others. If this connection fails, the unit continues to scroll through the table until the next successful connection.

The host list supports a minimum of 1 and a maximum of 12 entries. Each entry contains an IP address and a port number.

Note: *The host list is disabled for Manual and Modem Mode. The unit does not accept a data connection from a remote device when the hostlist option is enabled.*

To configure the unit's host list:

- On the main menu, click **Hostlist**.

Figure 6-4. Hostlist Settings

LANTRONIX® Firmware Version: V6.3.0.1T2
MAC Address: 00-20-4A-23-11-B2

Hostlist Settings

Retry Settings
 Retry Counter: Retry Timeout:

Host Information

No.	Host Address	Port	No.	Host Address	Port
1	<input type="text" value="0.0.0.0"/>	<input type="text" value="0"/>	2	<input type="text" value="0.0.0.0"/>	<input type="text" value="0"/>
3	<input type="text" value="0.0.0.0"/>	<input type="text" value="0"/>	4	<input type="text" value="0.0.0.0"/>	<input type="text" value="0"/>
5	<input type="text" value="0.0.0.0"/>	<input type="text" value="0"/>	6	<input type="text" value="0.0.0.0"/>	<input type="text" value="0"/>
7	<input type="text" value="0.0.0.0"/>	<input type="text" value="0"/>	8	<input type="text" value="0.0.0.0"/>	<input type="text" value="0"/>
9	<input type="text" value="0.0.0.0"/>	<input type="text" value="0"/>	10	<input type="text" value="0.0.0.0"/>	<input type="text" value="0"/>
11	<input type="text" value="0.0.0.0"/>	<input type="text" value="0"/>	12	<input type="text" value="0.0.0.0"/>	<input type="text" value="0"/>

- Enter or modify the following fields:

Retry Settings

Retry Counter	Enter the value for the number of times the XPress DR+ should attempt to retry connecting to the host list. The default setting is 3 .
Retry Timeout	Enter the duration (in seconds) the XPress DR+ should abandon attempting a connection to the host list. The default setting is 250 .

Host Information

Host Address	Enter or modify the host's IP address.
Port	Enter the target port number.

- When finished, click the **OK** button.
- To save and reboot, click **Apply Settings** on the main menu.

Channel Configuration

The Channel 1 and Channel 2 configurations define how the serial ports respond to network and serial communication.

Note: Channel 1 and Channel 2 have the same defaults except for the port number (10001 for Channel 1 and 10002 for Channel 2). The procedures below are for Channel 1; they are the same for Channel 2.

Serial Settings

To configure the channel's serial settings:

1. On the main menu, click **Serial Settings** (below Channel 1) to display the Serial Settings window.

Figure 6-5. Channel Serial Settings

The screenshot shows the LANTRONIX web manager interface. At the top, the LANTRONIX logo is on the left, and the firmware version (V6.3.0.1T2) and MAC address (00-20-4A-23-11-B2) are on the right. A navigation menu on the left lists various settings categories. The main content area is titled 'Serial Settings' and is for 'Channel 1'. It features a 'Disable Serial Port' checkbox. Below that is the 'Port Settings' section with dropdown menus for Protocol (RS232), Baud Rate (9600), Data Bits (8), Parity (None), Stop Bits (1), and Flow Control (None). The 'Pack Control' section includes an 'Enable Packing' checkbox, an 'Idle Gap Time' dropdown (12 msec), and radio buttons for 'Match 2 Byte Sequence' (No) and 'Send Frame Only' (No). 'Match Bytes' are set to 0x00. The 'Flush Mode' section has two sub-sections: 'Flush Input Buffer' and 'Flush Output Buffer', each with radio buttons for 'With Active Connect', 'With Passive Connect', and 'At Time of Disconnect', all of which are set to 'No'. An 'OK' button is at the bottom.

2. In the available fields, enter the following information:

Channel 1

Disable Serial Port	When selected, disables communication through the serial port. The serial port is enabled by default.
----------------------------	---

Port Settings

Protocol	From the drop-down menu, select the protocol type for the selected channel. The default setting is RS232 . Note: Configuring RS-485 is not permitted.
Flow Control	Flow control manages data flow between devices in a network to ensure the data is processed efficiently. Too much data arriving before a device is prepared to manage it causes lost or retransmitted data. None is the default setting.
Baud Rate	The unit and attached serial device, such as a modem, must agree on a speed or baud rate to use for the serial connection. Valid baud rates are 300, 600, 1200, 2400, 4800, 9600 (default), 19200, 38400, 57600, 115200, or 230400.

Data Bits	Indicates the number of bits in a transmitted data package. The default setting is 8 .
Parity	Checks for the parity bit. The default setting is None .
Stop Bits	The stop bit follows the data and parity bits in serial communication. It indicates the end of transmission. The default setting is 1 .

Pack Control

Enable Packing	<p>Select to enable packing on the XPress DR+. Disabled by default.</p> <p>Two firmware-selectable packing algorithms define how and when packets are sent to the network.</p> <p>The standard algorithm is optimized for applications in which the unit is used in a local environment, allowing for very small delays for single characters, while keeping the packet count low.</p> <p>The alternate packing algorithm minimizes the packet count on the network and is especially useful in applications in a routed Wide Area Network (WAN). Adjusting parameters in this mode can economize the network data stream.</p>
Idle Gap Time	Select the maximum time for inactivity. The default time is 12 milliseconds.
Match 2 Byte Sequence	Use to indicate the end of a series of data to be sent as one group. The sequence must occur sequentially to indicate end of the data collection to the XPress DR+. The default setting is No .
Match Bytes	Use to indicate the end of a series of data to be sent as one group. Set this value to 00 if specific functions are not needed.
Send Frame Only	After the detection of the byte sequence, indicates whether to send the data frame or the entire buffer. Select Yes to send only the data frame. The default setting is No .
Send Trailing Bytes	Select the number of bytes to send after the end-of-sequence characters. The default setting is None .

Flush Input Buffer (Serial to Network)

With Active Connect	Select Yes to clear the input buffer with a connection that is initiated from the device to the network. The default setting is No .
With Passive Connect	Select Yes to clear the input buffer with a connection initiated from the network to the device. The default setting is No .
At Time of Disconnect	Select Yes to clear the input buffer when the network connection to or from the device is disconnected. The default setting is No .

Flush Output Buffer (Network to Serial)

With Active Connect	Select Yes to clear the output buffer with a connection that is initiated from the device to the network. The default setting is No .
With Passive Connect	Select Yes to clear the output buffer with a connection initiated from the network to the device. The default setting is No .

At Time of Disconnect	Select Yes to clear the output buffer when the network connection to or from the device is disconnected. The default setting is No .
------------------------------	--

- When finished, click the **OK** button.
- To save and reboot, click **Apply Settings** on the main menu.

Connection Settings - TCP

To configure a channel's TCP settings:

- On the main menu, click **Connection**. The Connection Settings window for the channel displays.

Figure 6-6. TCP Connection Settings

The screenshot shows the LANTRONIX web manager interface for configuring TCP connection settings for Channel 1. The top header displays the LANTRONIX logo, Firmware Version: V6.3.0.1T2, and MAC Address: 00-20-4A-23-11-B2. The navigation menu on the left includes options like Network, Server, Serial Tunnel, Channel 1, Channel 2, WLAN, Apply Settings, and Apply Defaults. The main configuration area is titled 'Connection Settings' and is divided into several sections:

- Channel 1**: The selected channel.
- Connect Protocol**: Protocol is set to TCP.
- Connect Mode**:
 - Passive Connection:** Accept Incoming is set to Yes; Password Required is set to No; Password field is empty.
 - Active Connection:** Active Connect is set to None; Start Character is 0x0D (in Hex); Modem Mode is set to None.
 - Modem Escape Sequence Pass Through is set to Yes.
- Endpoint Configuration:** Local Port is 10001; Remote Port is 0; Remote Host is 0.0.0.0; Auto increment for active connect is unchecked.
- Common Options:** Telnet Mode is Disable; Connect Response is None; Terminal Name is empty; Use Hostlist is No; LED is Blink.
- Disconnect Mode:** On Mdm_Ctrl_In Drop is No; Hard Disconnect is Yes; Check EOT(Ctrl-D) is No; Inactivity Timeout is 0 mins and 0 secs.

An **OK** button is located at the bottom right of the configuration area.

2. In the available fields, enter or modify the following information:

Connect Protocol

Protocol	From the drop-down menu, select TCP .
-----------------	--

Connect Mode: Passive Connection

Accept Incoming	Select Yes to accept incoming connections. The default setting is Yes .
Password Required	Determines whether a password is required for an incoming passive connection. This field is not available when a password is set for Telnet mode. The default setting is No .
Password	If Password Required was set to Yes , enter the password for passive connections.

Connect Mode: Active Connection

Active Connect	Select None (default) to disable Active Connect . Otherwise, select the connection type from the drop-down list: <ul style="list-style-type: none"> ◆ With Any Character: Attempts to connect when any character is received from the serial port. ◆ With Active Mdm Ctrl In: Accepts external connection requests only when the modem_control_in input is asserted. ◆ With Start Character: Attempts to connect when it receives a specific start character from the serial port. The default start character is carriage return. ◆ Manual Connection: Attempts to connect when directed by a command string received from the serial port. ◆ Auto Start: Automatically connects to the remote IP address and port after booting up.
Start Character	If Active Connect is set to With Start Character , enter the start character in this field. The default setting is 0D .
Modem Mode	Indicates the on-screen response type when in Modem Mode (if Modem Mode is enabled). The default setting is None .

Endpoint Configuration

Local Port	Enter the local port number.
Auto increment for active connect	Select to auto-increment the local port number for new outgoing connections. The range of auto-incremented port numbers is 50,000 to 59,999 and loops back to the beginning when the maximum range is reached. Disabled by default.
Remote Port	Enter the remote port number.
Remote Host	Enter the IP address of the remote device.

Common Options

Telnet Mode	This field is available for configuration only when Active Connect is set to None . Select Enable to permit Telnet communication to the XPress DR+.
Terminal Name	This field is available for configuration only when Telnet Mode is set to Enable .

	Use the terminal name for the Telnet terminal type. Enter only one name. When this option is enabled, the unit also reacts to the end of record (EOR) and binary options, which can be used for applications such as terminal emulation to IBM hosts.
Connect Response	A single character is transmitted to the serial port when there is a change in connection state. Default setting is None .
Use Hostlist	If this option is set to True , the device server scrolls through the host list until it connects to a device listed in the host list table. Once it connects, the unit stops trying to connect to any others. If this connection fails, the unit continues to scroll through the table until it connects to another IP in the host list. The host list is disabled for Manual Mode and for Modem Mode. The unit will not accept a data connection from a remote device when the host list option is enabled.
LED	Select Blink for the status LEDs to blink upon connection or None for no LED output. The default setting is Blink .

Disconnect Mode

On Mdm_Ctrl_In Drop	Set to Yes for the network connection to or from the serial port to drop when modem_control_in transitions from a high state to a low state. The default setting is No .
Hard Disconnect	When set to Yes , the TCP connection closes even if the remote site does not acknowledge the disconnect request.
With EOT	Select Yes to drop the connection when Ctrl-D or Hex 04 is detected. Both Telnet Mode and Disconnect with EOT must be enabled for Disconnect with EOT to function properly. Ctrl+D is only detected going from the serial port to the network. The default setting is No .
Inactivity Timeout	Use this parameter to set an inactivity timeout. The unit drops the connection if there is no activity on the serial line before the set time expires. Enter time in the format <i>mm:ss</i> , where <i>m</i> is the number of minutes and <i>s</i> is the number of seconds. To disable the inactivity timeout, enter 00:00 .

- When finished, click the **OK** button.
- To save and reboot, click **Apply Settings** on the main menu.

Connection Settings - UDP

To configure a channel's UDP settings:

- On the main menu, click **Connection**. The Connection Settings window for the selected channel displays.
- In the available fields, enter or modify the following information:

Figure 6-7. UDP Connection Settings

LANTRONIX® Firmware Version: V6.3.0.1T2
MAC Address: 00-20-4A-23-11-B2

Connection Settings

Channel 1

Connect Protocol
Protocol:

Datagram Mode:
Datagram Type: Accept Incoming:

Endpoint Configuration:
Local Port: Remote Port:
Remote Host:

Device Address Table:

No.	Dev Addr	No.	Dev Addr	No.	Dev Addr	No.	Dev Addr
0	<input type="text" value="0"/>	1	<input type="text" value="0"/>	2	<input type="text" value="0"/>	3	<input type="text" value="0"/>
4	<input type="text" value="0"/>	5	<input type="text" value="0"/>	6	<input type="text" value="0"/>	7	<input type="text" value="0"/>
8	<input type="text" value="0"/>	9	<input type="text" value="0"/>	10	<input type="text" value="0"/>	11	<input type="text" value="0"/>
12	<input type="text" value="0"/>	13	<input type="text" value="0"/>	14	<input type="text" value="0"/>	15	<input type="text" value="0"/>

Connect Protocol

Protocol	Select UDP from the drop-down menu.
-----------------	--

Datagram Mode

Datagram Type	Configures the remote IP or network broadcast address and the remote port. Enter 01 for directed or broadcast UDP. The default setting is 00 .
Accept Incoming	Select Yes to accept incoming UDP datagrams.

Endpoint Configuration

Local Port	Enter the local port number.
Remote Port	Enter the port number of the remote device.
Remote Host	Enter the IP address of the remote device.
Device Address Table	<p>The table is enabled when Datagram Type is set to FD. Enter values between 1 and 255 to identify units on the local network of device servers.</p> <p><i>Note: Lantronix Tech Support supports Datagram type 01. Datagram Type FD is for OEM use.</i></p>

- When finished, click the **OK** button.
- To save and reboot, click **Apply Settings** on the main menu.

WLAN Configuration (XPress DR+W only)

Once you have initially configured the wireless unit's network and WLAN settings, you can modify them in Web Manager. For information on initial configuration, see [Chapter 4: XPress DR+W](#).

Without adequate protection, a wireless LAN is susceptible to access by unauthorized users.

The XPress DR+W WLAN Settings menu permits the following actions:

- ◆ Configuration of the wireless network profile available for activation
- ◆ Configuration of the wireless network security settings
- ◆ Configuration of advanced settings such as radio power management

Note: Due to regulations, the country-specific setting has been removed from the setup menu and Web Manager. However, we provide a separate utility for changing the **Country/Zone** setting. The utility is called *SetZone* and is included on the XPress DR+W CD. It is also available for download from the Lantronix web site.

The syntax is *SetZone* <IP address> [<zone abbreviation>]

Leaving the zone blank causes the utility to report the current setting only. Following are valid zone abbreviations. These settings are consistent with IEEE802.11b/g zones:

US=United States	JP=Japan
CA=Canada	OT=Others, such as Europe (excluding France), Asia, Africa, and Australia
FR=France	
SP=Spain	

To configure the XPress DR+W's WLAN settings:

1. Select **WLAN** from the main menu to open the WLAN Settings window.

Figure 6-8. WLAN Settings – Ad Hoc Network Type

The screenshot displays the LANTRONIX web manager interface. At the top, the LANTRONIX logo is on the left, and the firmware version (V6.3.0.1T2) and MAC address (00-20-4A-23-11-B2) are on the right. A navigation menu on the left includes options like Network, Server, Serial Tunnel, Channel 1, Channel 2, WLAN (highlighted), Apply Settings, and Apply Defaults. The main content area is titled 'WLAN Settings' and is divided into three sections: 'Wireless Network Configuration', 'Wireless Network Security', and 'Advanced Settings'. In the 'Wireless Network Configuration' section, the Network Name (SSID) is 'LTPX_IBSS', Network Type is 'Ad Hoc' (selected), and Channel is 'Channel 11' in the 'United States'. The 'Wireless Network Security' section shows Security set to 'None', Authentication and Encryption also set to 'None', Key Type set to 'Hex', and empty fields for Key and Retype Key. The 'Advanced Settings' section shows TX Data rate set to '11 Mbps' with 'Auto fallback' checked, and Radio Power Management set to 'Disable'. An 'OK' button is located at the bottom right of the settings area.

Figure 6-9. WLAN Settings – Infrastructure Network Type

The screenshot shows the LANTRONIX Web Manager interface. At the top, the LANTRONIX logo is on the left, and the Firmware Version (V6.3.0.1RC1) and MAC Address (00-20-4A-23-11-B2) are on the right. A navigation menu on the left includes options like Network, Server, Serial Tunnel, Channel 1, Channel 2, WLAN (highlighted), Apply Settings, and Apply Defaults. The main content area is titled 'WLAN Settings' and is divided into three sections: 'Wireless Network Configuration', 'Wireless Network Security', and 'Advanced Settings'. In the 'Wireless Network Configuration' section, the Network Name (SSID) is 'LTPX_JBSS', Network Type is 'Infrastructure', and Channel is 'Channel 11' (United States). The 'Wireless Network Security' section shows Security as 'WPA', Authentication as 'Pre-Shared Key (PSK)', Encryption as 'TKIP', and Key Type as 'Hex'. The 'Advanced Settings' section shows TX Data rate as '11 Mbps' (Auto fallback checked) and Radio Power Management as 'Enable'.

2. Enter or modify the following fields:

Wireless Network Configuration

Network Name (SSID)	Enter the name of the wireless network (SSID). The XPress DR+W connects to this wireless network.
Network Type	Select Infrastructure or Ad Hoc . The default setting is Ad Hoc . Network type is also referred to as the network <i>topology</i> .
Channel	Configurable only when Network Type is Ad Hoc . Select from the pull-down menu the radio channel for the Ad Hoc network. The default value is 11 .

Wireless Network Security

Security	<p>As a security measure, enable WEP, WPA, or WPA2/802.11i on the XPress DR+W. WPA and WPA2/802/11i are not available when Ad Hoc is the network type. By default, wireless security is disabled.</p> <p>Note: The WPA2/802.11i mode complies with the Robust Secure Network specified in the IEEE standard 802.11i. It enables the AES-based strong CCMP encryption.</p>
-----------------	---

WEP Options

Authentication	Select an authentication scheme (Open/None or Shared) from the drop down menu.
Encryption	Select the encryption type (64 bit or 128 bit for WEP) from the pull-down menu. 64 bit is the default encryption for WEP.
Key Type	Select the key type (Hex or Passphrase).
Key and Retype Key	<p>If the selected key type is Hex: Enter the Encryption Key as a hexadecimal value according the following guidelines:</p> <ul style="list-style-type: none"> ◆ Valid Hex alphanumeric characters are 0-9 and A-F. ◆ 64 bit hex = 5 bytes represented as xx-xx-xx-xx-xx. Example: 01-A3-47-E5-C9 ◆ 128 bit hex = 13 bytes represented as xx-xx-xx-xx-xx-xx-xx-xx-xx-xx-xx-xx-xx-xx-xx-xx. Example: A1-B2-C3-E4-D5-F6-98-74-B7-65-A8-D3-F2 <p>If the selected key type is Passphrase: Enter the key as a string. A passphrase is a sentence that is translated into hex by a hashing algorithm. Example: My dog has spots and likes to chase cats.</p> <p>A passphrase of more than 20 characters is recommended. Maximum length is 63 characters, including spaces and punctuation characters.</p> <p>Passphrase input is not the same as ASCII input. The passphrase input is safer because it has up to 63 chars. ASCII input has a maximum of 5 (WEP64) or 13 (WEP128) bytes and limits the number of key combinations.</p>

WPA Options

Authentication	Select Pre-Shared Keys from the drop-down list.
Encryption	Select the encryption type from the pull-down menu. TKIP is the default.
Key Type	Select the key type (Hex or Passphrase).
Key	<p>Enter the Encryption Key in hexadecimal value if Hex is selected as the key type. Enter the key as a string if Passphrase is selected as the key type. Passphrase input is not the same as ASCII input.</p> <p>A passphrase of more than 20 characters is recommended. Spaces and punctuation characters are permitted.</p>

WPA2/802.11i Options

Authentication	Select Pre-Shared Keys from the drop-down list.
Encryption	Select the encryption type from the pull-down menu. CCMP is the default encryption.
Key Type	Select the key type (Hex or Passphrase).
Key	Enter the Encryption Key in hexadecimal value if Hex is selected as the key type. Enter the key as a string if Passphrase is selected as the key type. Passphrase input is not the same as ASCII input. A passphrase of more than 20 characters is recommended. Spaces and punctuation characters are permitted.

Advanced Settings

TX Data Rate	<p>The XPress DR+W permits the control of the transmission data rate. Click the Auto check box to allow the unit to automatically set the data rate (or leave it unchecked to set the transmission rate manually). The default rate is 11 Mbps.</p> <p>If the Auto check box is selected, choose the maximum data rate from the drop down menu.</p> <p>If the Auto check box is not selected, select the fixed data rate (in Mbps) from the drop down menu.</p> <p>Note: The XPress DR+W supports the following additional rates: 18 Mbps, 24 Mbps, 36 Mbps, and 54 Mbps.</p>
Radio Power Management	Power management reduces the overall power consumption of the XPress DR+W unit. Selecting Enable increases the response time. Power management is not available in Ad Hoc mode.

Applying Settings

1. To save and apply the configuration changes to the device server, click the **Apply Settings** button.

Note: Clicking **OK** on each page does not change the configuration on the device. **OK** tells the XPress DR+ what changes to use; **Apply Settings** makes the changes permanent and reboots the XPress DR+.

Factory Defaults

1. Click the **Apply Defaults** button to set the device server back to the default settings. For details see [Default Settings](#) on page 92.
2. Click **yes** to set factory settings, or click **No** to cancel.

Chapter 7: Configuration Using Telnet or Serial Port (Setup Mode)

As an alternative to using a web browser, as described in the previous chapter, you can use the following procedures remotely or locally:

- ◆ Use a Telnet connection to configure the unit over the network.
- ◆ Use a terminal or terminal emulation program to access the serial port locally.

The series of prompts at which you enter configuration settings is called **Setup Mode**.

Note: Detailed information about other setup methods is available from Lantronix Technical Support (<http://www.lantronix.com/support>).

The unit's configuration is stored in nonvolatile memory and is retained without power.

This chapter tells you how to access Setup Mode and the general procedure for using it. To complete the configuration, continue with [Chapter 8: Setup Mode: Server Configuration](#), [Chapter 9: Setup Mode: Channel Configuration](#), and [Chapter 10: Setup Mode: Advanced Settings](#).

Notes:

- ◆ The menus in the configuration chapters show a typical device. Your device may have different configuration options.
- ◆ For the latest firmware, release notes, and user documentation, go to the Lantronix web site (www.lantronix.com).
- ◆ To use Telnet for communication to an XPress DR+W over a wireless network, you must first configure the network and WLAN settings using a serial connection. See [Chapter 4: XPress DR+W](#).

Accessing Setup Mode

Telnet Connection

To configure the unit over the network, establish a Telnet connection to port 9999.

Note: You can also use *DeviceInstaller* to access Telnet. Select the device from the main window list, and click the **Telnet Configuration** tab. Skip steps 1 and 2 below.

To establish a Telnet connection:

1. From the Windows **Start** menu, click **Run** and type the following command, where x.x.x.x is the IP address, and 9999 is the unit's fixed network configuration port number:

Windows: telnet x.x.x.x 9999

2. Click **OK**. The following information displays.

Figure 7-1. MAC Address

```

*** Lantronix XPress DR+ Wireless IA Device Server ***
MAC address 00204A2311B2
Software version U6.3.0.1T2 <060826>

Press Enter for Setup Mode

Model: Device Server Plus+! <Firmware Code:IA>
    
```

3. To enter Setup Mode, **press Enter within 5 seconds**. The current configuration settings display, followed by the Change Setup menu.

Figure 7-2. Setup Menu Options

```

Change Setup:
 0 Server
 1 Channel 1
 2 Channel 2
 4 WLAN
 5 Expert
 6 Security
 7 Defaults
 8 Exit without save
 9 Save and exit
Your choice ? _
    
```

4. Select an option on the menu by entering the number of the option in the **Your choice ?** field and pressing **Enter**.
5. To enter a value for a parameter, type the value and press **Enter**, or to confirm a current value, just press **Enter**.
6. When finished, save the new configuration (option 9). The unit reboots.

Serial Port Connection

To configure the unit through a serial connection:

1. Connect a console terminal (VT100) or PC running a terminal emulation program from port 1 with the Lantronix supplied P/N: 500-103 RJ45-to-DB9F serial cable.
2. The default serial port settings are **9600 baud, 8 bits, no parity, 1-stop bit, no-flow control**.

Note: Reset the XPress DR+ unit by cycling the unit's power (turning the power off and back on). Immediately upon resetting the device, hold down the **x** key at the terminal (or emulation) while resetting the unit. **You must do this within three seconds of resetting the unit.**

At this point, the screen display is the same as when you use a Telnet connection. To continue, go to step 3 in *Telnet Connection* above.

Exiting Setup Mode

To exit setup mode:

You have two options:

- ♦ To save all changes and reboot the device, select option **9 Save and exit** from the Change Setup menu. All values are stored in nonvolatile memory.
- ♦ To exit the configuration mode without saving any changes or rebooting. Select option **8 Exit without save** from the Change Setup menu.

Chapter 8: Setup Mode: Server Configuration

This chapter explains how to configure the network settings for the XPress DR+ and XPress DR+W.

Server Configuration (Option 0)

You can configure the unit's basic network parameters when you select **Server configuration** (option 0).

Note: Current values display in parentheses.

Network Mode (XPress DR+W only)

The first prompt requires you to set the unit for wired or wireless use. **Wired** is the default.

Figure 8-1. Network Mode

```
Network mode: 0=Wired Only, 1=Wireless Only (0) ? _
```

The **IP Address**, **Set Gateway IP Address**, and **Netmask** fields display the current values.

Figure 8-2. Server Settings

```
IP Address : (000) .(000) .(000) .(000)
Set Gateway IP Address (N)
Netmask: Number of Bits for Host Part (0=default) (0)
Change telnet config password (N)
```

IP Address

If DHCP is not used to assign IP addresses, enter the IP address manually. The IP address must be set to a unique value in the network. Enter each octet and press **Enter** between each section. The current value displays in parentheses.

```
IP Address : (000) (000) (000) (000) _
```

If DHCP is used, the third octet of the IP address sets the BootP/DHCP/AutoIP options. The following table shows the bits you can manually configure to force the XPress DR+ to disable AutoIP, DHCP, or BootP. To disable an option, set the appropriate bit.

Table 8-1. BootP/DHCP/AutoIP options

Options	Bit	Value
AutoIP	0	1
DHCP	1	2
BootP	2	4

For example, if the third octet is 0.0.5.0, the AutoIP and BootP options are disabled; only DHCP is enabled. (The value 5 results from adding the binary equivalents of 0 and 2.) This is the most common setting when using DHCP.

Set Gateway IP Address

The gateway address, or router, allows communication to other LAN segments. The gateway address should be the IP address of the router connected to the same LAN segment as the unit. The gateway address must be within the local network. The default setting is **N** (No), meaning the gateway address has not been set. To set the gateway address, type **Y** and enter the address.

```
Set Gateway IP Address (N) ? Y
Gateway IP addr ((000) (000) (000) (000)) _
```

Netmask: Number of Bits for Host Part

A netmask defines the number of bits taken from the IP address that are assigned for the host part.

```
Netmask: Number of Bits for Host Part (0=default) (0) _
```

Note: Class A: 24 bits; Class B: 16 bits; Class C: 8 bits

The unit prompts for the number of host bits to be entered, then calculates the netmask, which appears in standard decimal-dot notation (for example, 255.255.255.0) when the saved parameters display.

Table 8-2. Standard IP Network Netmasks

Network Class	Host Bits	Netmask
A	24	255.0.0.0
B	16	255.255.0.0
C	8	255.255.255.0

Change Telnet Configuration Password

Setting the Telnet configuration password prevents unauthorized access to Setup Mode through a Telnet connection to port 9999 or through web pages.

Please protect your device from unauthorized access and follow the instructions below:

- ◆ Always select **Y** to enable Telnet/Web Manager password
- ◆ Enable the enhanced password setting and create a strong 16-character password. For details, see [Security Settings \(Option 6\)](#) on page 90.

Note: We do not recommend that you only use the 4-character basic password as it does not offer sufficient security. Using no password is very dangerous.

```
Change telnet config password (N) ? _
```

DHCP Name

If a DHCP server has automatically assigned the IP address and network settings, you can discover the unit by using the DeviceInstaller network search feature.

There are three methods for assigning DHCP names to the unit.

- ◆ **Default DHCP Name:** If you do not change the DHCP name, and you are using an IP of 0.0.0.0, then the DHCP name defaults to CXXXXXX (XXXXXX is the last 6 digits of the MAC address shown on the label on the bottom/side of the unit). For example, if the MAC address is 00-20-4A-12-34-56, then the default DHCP name is C123456.
- ◆ **Custom DHCP Name:** You can create your own DHCP name. If you are using an IP address of 0.0.0.0, then the last option in Server configuration is **Change DHCP device name**. This option allows you to change the DHCP name to an alphanumeric name (LTX in our example).

```
Change DHCP device name (not set) ? (N) Y
Enter new DHCP device name : LTX
```

- ◆ **Numeric DHCP Name:** You can change the DHCP name by specifying the last octet of the IP address. When you use this method, the DHCP name is LTXYY where YY is what you chose for the last octet of the IP address. If the IP address you specify is 0.0.0.12, then the DHCP name is LTX12. This method only works with 2 digit numbers (01-99).

Chapter 9: Setup Mode: Channel Configuration

This chapter explains how to configure a serial port.

Notes:

- ◆ Current values display in parenthesis.
- ◆ You must enter some values in hexadecimal notation. (See [Appendix D: Binary to Hexadecimal Conversions](#)).

Channel 1 (Option 1) and Channel 2 (Option 2)

Note: Channel 1 and Channel 2 have the same defaults except for the port number (10001 for Channel 1 and 10002 for Channel 2).

Select **Channel 1** (option 1) or **Channel 2** (option 2) from the Change Setup menu to define how the serial port responds to network and serial communications. The following sections describe the configurable parameters within the **Channel** configuration menu.

Figure 9-1. Serial Port Parameters

```
Baudrate <9600> ?
I/F Mode <4C> ?
Flow <00> ?
Port No <10001> ?
ConnectMode <C0> ?
Send '+++' in Modem Mode <Y> ?
Auto increment source port <N> ?
Remote IP Address : <000> .<000> .<000> .<000>
Remote Port <0> ?
DisConnMode <00> ?
FlushMode <00> ?
DisConnTime <00:00> ? :
SendChar 1 <00> ?
SendChar 2 <00> ?
```

Baudrate

The unit and attached serial device, such as a Programmable Logic Controller (PLC), must agree on a speed or baud rate to use for the serial connection. Valid baud rates are 300, 600, 1200, 2400, 4800, 9600 (default), 19200, 38400, 57600, 115200, and 230400 baud.

```
Baudrate (9600) ? _
```

I/F (Interface) Mode

The Interface (I/F) Mode is a bit-coded byte entered in hexadecimal notation.

I/F Mode (4C) ? _

The following table displays available I/F Mode options.

Note: All bit positions in the table that are blank represent “don’t care” bits for that particular option, which can be set to either a 0 or 1 value.

Table 9-1. Interface Mode Options

I/F Mode Option	7	6	5	4	3	2	1	0
RS-232C ⁽¹⁾							0	0
RS-422/485 4-wire							0	1
RS-485 2-wire							1	1
7 Bit					1	0		
8 Bit					1	1		
No Parity			0	0				
Even Parity			1	1				
Odd Parity			0	1				
1 stop bit	0	1						
2 stop bits ⁽¹⁾	1	1						

⁽¹⁾ 2 stop bits are implemented by the software. This might influence performance.

The following table demonstrates how to build some common Interface Mode settings.

Table 9-2. Common Interface Mode Settings

Common I/F Mode Setting	Binary	Hex
RS-232C, 8-bit, No Parity, 1 stop bit	0100 1100	4C
RS-232C, 7-bit, Even Parity, 1 stop bit	0111 1000	78
RS-485 2-wire, 8-bit, No Parity, 1 stop bit	0100 1111	4F
RS-422, 8-bit, Odd Parity, 1 stop bit	0101 1101	5D

Flow

Flow control sets the local handshaking method for stopping serial input/output.

Flow (0) ? _

Use the following table to select flow control options:

Table 9-3. Flow Control Options

Flow Control Option	Hex
No flow control	00
XON/XOFF flow control	01
Hardware handshake with RTS/CTS lines	02
XON/XOFF pass characters to host	05

Port Number

The setting represents the source port number in TCP connections. It is the number that identifies the channel for remote initiating connections.

Port No (10001) ? _

The default setting for port 1 is **10001**. The default setting for Port 2 is **10002**. The range is 1-65535, except for the following reserved port numbers:

Table 9-4. Reserved Port Numbers

Port Numbers	Reserved for
1 – 1024	Reserved (well known ports)
9999	Telnet setup
14000-14009	Reserved for Redirector
30704	Reserved (77F0h)
30718	Reserved (77FEh)

Warning: We recommend that you not use the reserved port numbers for this setting as incorrect operation may result.

Use Port **0** for the outgoing local port to change with each connection. The port range is 50,000 to 59,999. Each subsequent connection increments the number by 1 (it wraps back around to 50,000).

Only use this automatic port increment feature to initiate a connection using TCP. Set the port to a non-zero value when the unit is in a passive mode or when using UDP instead of TCP.

Connect Mode

Connect Mode defines how the unit makes a connection, and how it reacts to incoming connections over the network.

ConnectMode (C0) ? _

Enter Connect Mode options in hexadecimal notation.

Note: All bit positions in the table that are blank represent “don’t care” bits, for that particular option, which can be set to either a 0 or 1 value.

Table 9-5. Connect Mode Options

Connect Mode Option	7	6	5	4	3	2	1	0
a) Incoming Connection								
Never accept incoming	0	0	0					
Accept with DTR Active	0	1	0					
Always Accept	1	1	0					
b) Response								
Nothing (quiet)				0				
Character response (C=connect, D=disconnect, N=unreachable)				1				
c) Active Startup								
No active startup					0	0	0	0
With any character					0	0	0	1
With DTR Active					0	0	1	0
With a specific start character					0	0	1	1
Manual connection					0	1	0	0
Autostart					0	1	0	1
Hostlist	0	0	1	0				
d) Datagram Type								
Directed UDP					1	1	0	0
e) Modem Mode								
No Echo			0	0		1	1	
Data Echo & Modem Response (Numeric)			0	1		1	1	1
Data Echo & Modem Response (Verbose)			0	1		1	1	0

Connect Mode Option	7	6	5	4	3	2	1	0
Modem Response Only (Numeric)			0	0	1	1	1	1
Modem Response Only (Verbose)			0	0	1	1	1	0

a) Incoming Connection

Never Accept Incoming	Rejects all external connection attempts.
Accept with DTR Active	Accepts external connection requests only when the DTR input is asserted. Cannot be used with Modem Mode.
Always Accept	Accepts any incoming connection when a connection is not already established. Default setting.

b) Response

Character Response	<p>A single character is transmitted to the serial port when there is a change in connection state: C = connected, D = disconnected, N = host unreachable.</p> <p>Single character mode specifies the character response. The IP address of the host connecting to the unit displays when the unit is in verbose mode. This option is overridden when the Active Start Modem Mode or Active Start Host List is in effect. Default setting is Nothing (quiet).</p>
---------------------------	--

c) Active Startup

No Active Startup	Does <i>not</i> attempt to initiate a connection under any circumstance. Default setting.
With Any Character	Attempts to connect when any character is received from the serial port.
With DTR Active	Attempts to connect when the DTR input changes from not asserted to asserted.
With a Specific Start Character	Attempts to connect when it receives a specific start character from the serial port. The default start character is carriage return.
Manual Connection	<p>Attempts to connect when directed by a command string received from the serial port. The first character of the command string must be a C (ASCII 0x43), and the last character must be either a carriage return (ASCII 0x0D) or a line feed (0x0A). No blanks or space characters may be in the command string. Between the first and last command string characters must be a full or partial destination IP address and may be a destination port number.</p> <p>The IP address must be in standard decimal-dot notation and may be a partial address, representing the least significant 1, 2, or 3 bytes of the remote IP address. The period is required between each pair of IP address numbers.</p> <p>If present, the port number must follow the IP address, must be presented as a decimal number in the range 1-65535, and must be preceded by a forward slash (ASCII 0x2F). The slash separates the IP address and the port number. If you omit the port number from a command string, the internally stored remote port number starts a connection.</p>

	<p>If a partial IP address is presented in a command string, it is interpreted to be the least significant bytes of the IP address and uses the internally stored remote IP address to provide the most significant bytes of the IP address. If the IP address entered is 0.0.0.0/0, the device server enters Monitor Mode.</p> <p>For example, if the remote IP address already configured in the unit is 129.1.2.3, then an example command string would be C3/7. (This would connect to 129.1.2.3 and port 7.) You may also use a different ending for the connection string. For example, C50.1/23 would connect you to 129.1.50.1 and port 23.</p>
--	---

Figure 9-2. Manual Connection Address Example

Command String	Result if remote IP is 129.1.2.3 and remote port is 1234
C121.2.4.5/1	Complete override; connection is started with host 121.2.4.5, port 1
C5	Connects to 129.1.2.5, port 1234
C28.10/12	Connects to 129.1.28.10, port 12
C0.0.0.0/0	Enters Monitor Mode

Autostart (Automatic Connection)	If you enable Autostart , the unit automatically connects to the remote IP address and remote port specified when the firmware starts.
Hostlist	<p>If you enable this option, the device server scrolls through the hostlist until it connects to a device listed in the hostlist table. Once it connects, the unit stops trying to connect to any others. If this connection fails, the unit continues to scroll through the table until it is able to connect to another IP in the hostlist.</p> <p>Hostlist supports a minimum of 1 and a maximum of 12 entries. Each entry contains the IP address and the port number. The hostlist is disabled for Manual and Modem Modes. The unit does not accept a data connection from a remote device when the hostlist option is enabled.</p>

Figure 9-3. Hostlist Option

```

Baudrate (9600) ?
I/F Mode (4C) ?
Flow (00) ?
Port No (10001) ?
ConnectMode (25) ?
Send '+++' in Modem Mode (Y) ?
Auto increment source port (N) ?

Hostlist :
01. IP : 172.019.000.001 Port : 00023
02. IP : 172.019.000.002 Port : 03001
03. IP : 172.019.000.003 Port : 10001

Change Hostlist ? (N) ? Y
01. IP address : (172) .(019) .(000) .(001) Port : (23) ?
02. IP address : (172) .(019) .(000) .(002) Port : (3001) ?
03. IP address : (172) .(019) .(000) .(003) Port : (10001) ?
04. IP address : (000) .(000) .(000) .(000)
Hostlist :
01. IP : 172.019.000.001 Port : 00023
02. IP : 172.019.000.002 Port : 03001
03. IP : 172.019.000.003 Port : 10001

Change Hostlist ? (N) ? N
Hostlist Retrycounter (3) ?
Hostlist Retrytimeout (250) ?
DisConnMode (00) ?
FlushMode (00) ?
DisConnTime (00:00) ? :
SendChar 1 (00) ?
SendChar 2 (00) ? _

```

To enable the hostlist:

1. Enter a **Connect Mode** of 0x20 (2X), where X is any digit. The menu shows you a list of current entries already defined in the product.
2. To delete, modify, or add an entry, select **Yes**. If you enter an IP address of **0.0.0.0**, that entry and all others after it are deleted.
3. After completing the hostlist, repeat the previous step if necessary to edit the hostlist again.
4. For **Retrycounter**, enter the number of times the Lantronix unit should try to make a good network connection to a hostlist entry that it has successfully ARPed. The range is 1-15, with the default set to **3**.
5. For **Retrytimeout**, enter the number of seconds the unit should wait before failing an attempted connection. The time is stored as units of milliseconds in the range of 1-65535. The default setting is **250**.

d) Datagram Type

Directed UDP	<p>When selecting this option, you are prompted for the Datagram type. Enter 01 for directed or broadcast UDP.</p> <p>When the UDP option is in effect, the unit never attempts to initiate a TCP connection because it uses UDP datagrams to send and receive data.</p>
---------------------	---

e) Modem Mode

In Modem (Emulation) Mode, the unit presents a modem interface to the attached serial device. It accepts AT-style modem commands and handles the modem signals correctly.

Normally, there is a modem connected to a local PC and a modem connected to a remote machine. A user must dial from the local PC to the remote machine, accumulating phone charges for each connection. Modem Mode allows you to replace modems with XPress DR+ units, and to use an Ethernet connection instead of a phone call. By not having to change communications applications, you avoid potentially expensive phone calls.

To select Modem Mode, set the Connect Mode to **C6** (no echo), **D6** (echo with full verbose), **D7** (echo with numeric response), **CF** (modem responses only, numeric response), or **CE** (modem responses only, full verbose).

Note: If the unit is in Modem Mode, and the serial port is idle, the unit can still accept network TCP connections to the serial port if Connect Mode is set to **C6** (no echo), **D6** (echo with full verbose), **D7** (echo with numeric response), **CF** (modem responses only, numeric response), or **CE** (modem responses only, full verbose).

Without Echo	In Modem Mode, echo refers to the echo of all of the characters entered in command mode; it does <i>not</i> mean to echo data that is transferred. Quiet Mode (without echo) refers to the modem <i>not</i> sending an answer to the commands received (or displaying what was typed).
Data Echo & Modem Response	Full Verbose: The unit echoes modem commands and responds to a command with a message string shown in the table below. Numeric Response: The unit echoes modem commands and responds to a command with a numeric response.
Modem Responses Only	Full Verbose: The unit does not echo modem commands and responds to a command with a message string shown in the table below. Numeric Response: The unit does not echo modem commands and responds to a command with a numeric response.

Table 9-6. Modem Mode Messages

Message	Meaning
Full Verbose	
OK	Command was executed without error.
CONNECT	A network connection has been established.
NO CARRIER	A network connection has been closed.
RING n.n.n.n.	A remote device, having IP address n.n.n.n, is connecting to this device.
Numeric Response	
0	OK
1	Connected
2	Ring
3	No Carrier
4	Error

Received commands must begin with the two-character sequence **AT** and be terminated with a carriage return character.

The unit ignores any character sequence received *not* starting with **AT**, and only recognizes and processes single **AT**-style commands. The unit treats compound **AT** commands as unrecognized commands.

If the **Full Verbose** option is in effect, the unit responds to an unrecognized command string that is otherwise formatted correctly (begins with **AT** and ends with carriage return) with the "OK" message and takes no further action.

If the **Numeric Response** option is in effect, the unit responds to an unrecognized command string that is otherwise formatted correctly with the "0" message and takes no further action.

When an active connection is in effect, the unit transfers data and does not process commands received from the serial interface.

When a connection is terminated or lost, the unit reverts to command mode.

When an active connection is in effect, the unit terminates the connection if it receives the following sequence from the attached serial device:

- ◆ No serial data is received for one second.
- ◆ The character sequence +++ is received, with no more than one second between each two characters.
- ◆ No serial data is received for one second after the last + character. At this time, the unit responds affirmatively per the selected echo/response mode.
- ◆ The character string **ATH** is received, terminated with a carriage return. The unit responds affirmatively according to the selected echo/response mode and drops the network connection. The serial interface reverts to accepting command strings.

If this sequence is not followed, the unit remains in data transfer mode.

Table 9-7. Modem Mode Commands

Modem Mode Command	Function
ATDTx.x.x.x,pppp or ATDTx.x.x.x/pppp	Makes a connection to an IP address (x.x.x.x) and a remote port number (pppp).
ATDTx.x.x.x	Makes a connection to an IP address (x.x.x.x) and the remote port number defined within the unit.
ATD0.0.0.0	Forces the unit into Monitor Mode if a remote IP address and port number are defined within the unit.
ATD	Forces the unit into Monitor Mode if a remote IP address and port number are not defined within the unit.
ATDx.x.x.x	Makes a connection to an IP address (x.x.x.x) and the remote port number defined within the unit.
ATH	Hangs up the connection (entered as +++ATH).

Modem Mode Command	Function
ATS0=n	Enables or disables connections from the network going to the serial port. n=0 disables the ability to make a connection from the network to the serial port. n=1-9 enables the ability to make a connection from the network to the serial port. n>1-9 is invalid.
ATEn	Enables or disables character echo and responses. n=0 disables character echo and responses. n=1 enables character echo and responses.
ATVn	Enables numeric response or full verbose. n=0 enables numeric response. n=1 enables full verbose.

Note: The unit recognizes these AT commands as single commands such as ATE0 or ATV1; it does not recognize compound commands such as ATE0V.

Send the Escape Sequence (+++) in Modem Mode

```
Send '+++' in Modem Mode (Y) ? _
```

Disable or enable the unit's ability to send the escape sequence. The default is **Y** (Yes) (send the escape sequence).

Auto Increment Source Port

```
Auto increment source port (N) ? _
```

Y (Yes) auto increments the source port. The XPress DR+ increments the port number used with each new connection.

Remote IP Address

This is the destination IP address used with an outgoing connection.

```
Remote IP Address : (000) (000) (000) (000) _
```

Note: This option does not display when Hostlist is enabled from the **ConnectMode** prompt (see [Connect Mode](#) on page 73 for more information).

Remote Port

You must set the remote TCP port number for the unit to make outgoing connections. This parameter defines the port number on the target host to which a connection is attempted.

```
Remote Port ( 0) ? _
```

To connect an ASCII terminal to a host using the unit for login purposes, use the remote port number 23 (Internet standard port number for Telnet services).

Note: This option does not display when Hostlist is enabled from the **ConnectMode** prompt (see [Connect Mode](#) on page 73 for more information).

DisConnMode

This setting determines the conditions under which the unit will cause a network connection to terminate.

```
DisConnMode ( 0) ? _
```

Notes:

In *DisConnMode* (Disconnect Mode), DTR drop either drops the connection or is ignored.

Note: All bit positions in the table that are blank represent “don’t care” bits, for that particular option, which can be set to either a 0 or 1 value.

Table 9-8. Disconnect Mode Options

Disconnect Mode Option	7	6	5	4	3	2	1	0
Disconnect with DTR drop ⁽⁶⁾	1							
Ignore DTR	0							
Telnet mode and terminal type setup ⁽¹⁾		1						
Channel (port) password ⁽²⁾				1				
Hard disconnect ⁽³⁾					0			
Disable hard disconnect					1			
State LED off with connection ⁽⁴⁾								1
Disconnect with EOT (^D) ⁽⁵⁾			1					

(1) The XPress DR+ sends the "Terminal Type" upon an outgoing connection.

(2) A password is required for a connection to the serial port from the network.

(3) The TCP connection closes even if the remote site does not acknowledge the disconnection.

(4) When there is a network connection to or from the serial port, the state LED turns off instead of blinking.

(5) When **Ctrl+D** or **Hex 04** is detected, the connection is dropped. Both **Telnet Mode** and **Disconnect with EOT** must be enabled for **Disconnect with EOT** to function properly. **Ctrl+D** is only detected going from the serial port to the network.

(6) When DTR transitions from a high state to a low state, the network connection to or from the serial port drops.

Flush Mode (Buffer Flushing)

Using this parameter, you can control line handling and network buffers with connection startup and disconnect.

```
FlushMode ( 0 ) ? _
```

You can also select between two different packing algorithms.

Note: All bit positions in the table that are blank represent “don’t care” bits, for that particular option, which can be set to either a 0 or 1 value.

Table 9-9. Flush Mode Options

Function	7	6	5	4	3	2	1	0
Input Buffer (Serial to Network)								
Clear with a connection initiated from the device to the network				1				
Clear with a connection initiated from the network to the device			1					
Clear when the network connection to or from the device is disconnected		1						
Output Buffer (Network to Serial)								
Clear with a connection initiated from the device to the network								1
Clear with a connection initiated from the network to the device							1	
Clear when the network connection to or from the device is disconnected						1		
Alternate Packing Algorithm (Pack Control)								
Enable	1							

Pack Control

The packing algorithms define how and when packets are sent to the network. The standard algorithm is optimized for applications in which the unit is used in a local environment, allowing for very small delays for single characters, while keeping the packet count low. The alternate packing algorithm minimizes the packet count on the network and is especially useful in applications in a routed Wide Area Network (WAN). Adjusting parameters in this mode can economize the network data stream.

Pack control settings are enabled in Flush Mode. Set this value to **00** if you do not need specific functions.

Note: All bit positions in the table that are blank represent “don’t care” bits, for that particular option, which can be set to either a 0 or 1 value.

Table 9-10. Pack Control Options

Option	7	6	5	4	3	2	1	0
Packing Interval								
Interval: 12ms							0	0
Interval: 52ms							0	1
Interval: 250ms							1	0

Option	7	6	5	4	3	2	1	0
Interval: 5sec							1	1
Trailing Characters								
None					0	0		
One					0	1		
Two					1	0		
Send Characters								
2-Byte Send Character Sequence				1				
Send Immediately After Send chars			1					

Packing Interval

Packing Interval defines how long the unit should wait before sending accumulated characters. This wait period is between successive network segments containing data. For alternate packing, the default interval is **12 ms**.

Trailing Characters

In some applications, CRC, Checksum, or other trailing characters follow the end-of-sequence character; this option helps to adapt frame transmission to the frame boundary.

Send Characters

- ◆ If **2-Byte Send Character Sequence** is enabled, the unit interprets the sendchars as a 2-byte sequence; if this option is not enabled, the unit interprets them independently.
- ◆ If **Send Immediately After Characters** is *not* set, any characters already in the serial buffer are included in the transmission after a "transmit" condition is found. If this option is set, the unit sends immediately after recognizing the transmit condition (sendchar or timeout).

Note: A transmission might occur if status information needs to be exchanged or an acknowledgment needs to be sent.

DisConnTime (Inactivity Timeout)

Use this parameter to set an inactivity timeout. The unit drops the connection if there is no activity on the serial line before the set time expires. Enter time in the format *mm:ss*, where *m* is the number of minutes and *s* is the number of seconds.

DisConnTime (0: 0) ?:

To disable the inactivity timeout, enter **00:00**. Range is 0 (disabled) to 5999 seconds (99 minutes, 59 seconds). Default setting is **0**.

Send Characters

Enter up to two characters in hexadecimal representation in sendchar.

SendChar 1 (0) ? _
SendChar 2 (0) ? _

If the unit receives a character on the serial line that matches one of these characters, it sends the character immediately, along with any awaiting characters, to the TCP connection. This action minimizes the response time for specific protocol characters on the serial line (for example, ETX, EOT). Setting the first sendchar to **00** disables the recognition of the characters. Alternatively, the unit can interpret two characters as a sequence (see [Pack Control](#) on page 81).

Telnet Terminal Type

This parameter displays only if you enabled the terminal type option in Disconnect Mode. With this option enabled, you can use the terminal name for the Telnet terminal type. Enter only one name.

With terminal type option enabled, the unit also reacts to the EOR (end of record) and binary options, useful for applications like terminal emulation to IBM hosts.

Channel (Port) Password

This parameter appears only if the channel (port) password option is enabled in Disconnect Mode. With this option enabled, you can set a password on the serial port.

WLAN Settings (XPress DR+W Only)

Note: To use DeviceInstaller for communication to an XPress DR+W over a wireless network, you must first configure the network and WLAN settings using a serial connection. See [Chapter 4:XPress DR+W](#).

Before the XPress DR+W can communicate on an 802.11b/g wireless network, the WLAN settings must match the wireless network. By default, the XPress DR+W is set to Ad Hoc network mode, and its wireless Network Name (SSID) is **LTRX_IBSS**.

Note: Due to regulations, the country-specific setting has been removed from the setup menu and Web Manager. We provide a separate utility for changing the **Country/Zone** setting. The utility is called *SetZone* and is included in the XPress DR+W package. It is also available for download from the Lantronix web site (www.lantronix.com).

The syntax is *SetZone* <IP address> [<zone abbreviation>]

Leaving the zone blank causes the utility to report the current setting only. Following are valid zone abbreviations. These settings are consistent with IEEE802.11b/g zones:

US=United States	JP=Japan
CA=Canada	OT=Others, such as Europe
FR=France	(excluding France), Asia, Africa, and
SP=Spain	Australia

Without adequate protection, a wireless LAN is susceptible to access by unauthorized users. As such, XPress DR+W features the WPA security standard, WPA2 based on IEEE 802.11i. WEP is provided for backwards compatibility and interaction with older devices.

To modify WLAN settings, select **4 WLAN** from the Change Setup menu.

Topology

Select **Infrastructure** (ESS) mode or **Adhoc** (IBSS) mode. Infrastructure mode communicates with Access Points. Ad Hoc mode communicates only with other clients.

Topology 0=Infrastructure, 1=Adhoc (0) ? _

Network Name (SSID)

Enter the name of the network to which the XPress DR+W will connect.

Network name (LTRX_IBSS) ? _

Adhoc Network Channel

When **Adhoc** is selected in the **Topology** parameter, and the XPress DR+W cannot find the specified network, it creates one with that name by transmitting a beacon on the selected channel.

Channel (11) ? _

Only channels allowed in the country for which the XPress DR+W is designated can be selected. The country displays in the Setup Mode settings overview.

Security

The **Security Suite** prompt enables you to select the type of security. The XPress DR+W features WEP, WPA and WPA2/802.11i to secure all wireless communication. WPA and WPA2/802.11i are only available when the topology is **Infrastructure**.

Security suite: 0=none, 1=WEP, 2=WPA, 3=WPA2/802.11i (0) ?

Notes:

- ◆ In the WPA and WPA2 modes, the encryption setting denotes the lowest acceptable encryption method, CCMP > TKIP > WEP. For example, if the unit is configured for WEP, and the Access Point supports TKIP, the negotiation will result in TKIP being used. If the unit is configured for TKIP, and the Access Point only supports WEP, association will fail because the Access Point does not meet the unit's demands. (CCMP is only available in WPA2 mode.)
- ◆ Communication between the Access Point and a single wireless device is called unicast and uses the pairwise encryption method. Communication from the Access Point to many wireless devices at once is called multicast and uses the group encryption method.

To receive broadcast and multicast messages, the group encryption for all wireless devices communicating with the same access point must be equal. If any of these devices is WEP-only (no support for WPA), set the encryption to **TKIP+WEP**.

A group encryption lower than the pairwise encryption is necessary to use higher security with the XPress DR+W than other devices connecting to the same Access Point can support.

- ◆ CCMP is also called AES on products of other manufacturers. CCMP is an extension of AES and is the correct term. It provides the strongest current encryption method.

WEP

```
Topology: 0=Infrastructure, 1=Ad-Hoc (1) ? 1
Network name (SSID) (LTRX_IBSS) ?
Channel (11) ?
Security suite: 0=none, 1=WEP (0) ? 1
Authentication: 0=open/none, 1=shared (0) ?
Encryption: 1=WEP64, 2=WEP128 (1) ?
Display current key (N) ?
Change Key (N) ? Y
Key type 0=hex, 1=passphrase (0) ?
Enter Key: **-*-*-*-*
TX Key index (1) ?
```

Authentication selects whether the encryption keys are matched (**1** = shared) with those of the communication partner before passing through messages or not (**2** = open/none).

The **Encryption** prompt requests the length of the encryption key and the security strength. WEP64 uses a 40 bits/5 bytes key (option **1**). WPE128 uses a 104 bits/13 bytes key (option **2**).

Select **Y** (Yes) at the **Display current key** prompt to show the currently configured key/passphrase.

Select **Y** (Yes) at the **Change key** prompt to be able to modify the currently configured key.

The **Key type** indicates whether the new key is in hexadecimal or passphrase format.

Enter key prompts for the new encryption key.

Key Type	Encryption Key
Hex	<p>Enter the Encryption Key as a hexadecimal value according the following guidelines:</p> <ul style="list-style-type: none"> ◆ Valid hex alphanumeric characters are 0-9 and A-F. ◆ 64 bit hex = 5 bytes represented as xx-xx-xx-xx-xx. Example: 01-A3-47-E5-C9 ◆ 128 bit hex = 13 bytes represented as xx-xx-xx-xx-xx-xx-xx-xx-xx-xx-xx-xx-xx-xx. Example: A1-B2-C3-E4-D5-F6-98-74-B7-65-A8-D3-F2
Passphrase	<p>Enter the key as a string. A passphrase is a sentence that is translated into hex by a hashing algorithm. Example: My dog has spots and likes to chase cats.</p> <p>A passphrase of more than 20 characters is recommended. Maximum length is 63 characters, including spaces and punctuation characters.</p>

Key Type	Encryption Key
	<p>Passphrase input is not the same as ASCII input. The passphrase input is safer because it has up to 63 characters. ASCII input has a maximum of 5 (WEP64) or 13 (WEP128) bytes and limits the number of key combinations.</p> <p>Please refer to the other equipment's manual to determine the passphrase input style recommended.</p>

TX Key index selects the WEP key used for transmissions. Enter a value between 1 and 4. The default setting is 1. In case the WEP key is entered in hex, all keys (1-4) are the same. In case the WEP key is entered as a passphrase, the four WEP keys are generated according to the Linksys algorithms and will be different.

WPA

This firmware version allows only **Pre-Shared Keys (PSK)** for authentication.

```

Topology: 0=Infrastructure, 1=Ad-Hoc <1> ? 0
Network name <SSID> <LTRX_IBSS> ?
Security suite: 0=none, 1=WEP, 2=WPA, 3=WPA2/802.11i <1> ? 2
Display current key <N> ?
Change Key <N> ? Y
Key type 0=hex, 1=passphrase <0> ?
Enter Key: **-*-*-*-*-*-*-*-*-*-*-*-*-*-*-*-*-*-*-*-*-*-*-*-*-*-*-*-*-*
**-*-*-*-*-*-*-*-*-*-*
Encryption: 0=TKIP, 1=TKIP+WEP <1> ?
TX Data rate: 0=fixed, 1=auto fallback <1> ?
TX Data rate: 0=1, 1=2, 2=5.5, 3=11, 4=18, 5=24, 6=36, 7=54 Mbps <7> ?
Enable power management <N> ?
    
```

Select **Y** (Yes) at the **Display current key** prompt to show the currently configured key/passphrase,

Select **Y** (Yes) at the **Change key** prompt to be able to modify the currently configured key by selecting **Y** (Yes).

The **Key type** requests whether the new key is in hexadecimal or passphrase format. The default setting is **Passphrase**.

Enter key prompts for the new passphrase or hexadecimal key.

Key Type	Encryption Key
Hex	<p>Enter the Encryption Key as a hexadecimal value according the following guidelines:</p> <ul style="list-style-type: none"> ◆ Valid hex alphanumeric characters are 0-9 and A-F. ◆ 64 bit hex = 5 bytes represented as xx-xx-xx-xx-xx. Example: 01-A3-47-E5-C9 ◆ 128 bit hex = 13 bytes represented as xx-xx-xx-xx-xx-xx-xx-xx-xx-xx-xx-xx-xx-xx. Example: A1-B2-C3-E4-D5-F6-98-74-B7-65-A8-D3-F2
Passphrase	<p>Enter the key as a string. A passphrase is a sentence that is translated into hex by a hashing algorithm. Example: My dog has spots and likes to chase cats.</p> <p>A passphrase of more than 20 characters is recommended. Maximum length is 63 characters, including spaces and punctuation characters.</p> <p>Passphrase input is not the same as ASCII input. The passphrase input is safer because it has up to 63 characters. ASCII input has a maximum of 5</p>

Key Type	Encryption Key
	(WEP64) or 13 (WEP128) characters and limits the number of key combinations. Please refer to the other equipment's manual to determine the passphrase input style recommended.

Set the **Encryption** type to the minimum required security. The plus sign denotes that the group (broadcast) encryption method is different from the pairwise (unicast) encryption, in this case WEP and TKIP, respectively. For example, CCMP+TKIP => pairwise = CCMP, and group = TKIP.

WPA2/802.11i

The WPA2/802.11i mode complies with the Robust Secure Network specified in the IEEE standard 802.11i. It enables the AES-based strong CCMP encryption.

```
Topology: 0=Infrastructure, 1=Ad-Hoc (0) ? 0
Network name (SSID) (LTRX_IBSS) ?
Security suite: 0=none, 1=WEP, 2=WPA, 3=WPA2/802.11i (2) ? 3
Display current key (N) ?
Change Key (N) ? Y
Key type 0=hex, 1=passphrase (0) ? 1
Enter Key: *****
Encryption: 0=CCMP, 1=CCMP+TKIP, 2=CCMP+WEP, 3=TKIP, 4=TKIP+WEP (3) ?
```

Enter key prompts for the new passphrase. Maximum length is 63 characters; the recommended minimum is 20 characters.

Set the **Encryption** type to minimum required security. The plus sign denotes that the group (broadcast) encryption method is different from the pairwise (unicast) encryption. For example, CCMP+TKIP => pairwise = CCMP, and group = TKIP.

Fixed or Automatic Data Rate

The XPress DR+W permits the control of the transmission rate. Select **0** to set a fixed data rate, or select **1** to set an automatic fallback data rate. The default setting is **1** (auto).

```
TX Data rate 0=fixed, 1=auto fallback (1) ? _
```

Transmission Data Rate

If the above **TX Data rate** is set to **fixed**, the selected data rate is the XPress DR+W's fixed transmission rate. If the above **TX Data rate** is set to **auto**, the selected data rate is the XPress DR+W's maximum data rate. Lower data rates allow for larger distances. They may also be required when communicating with older devices. The default setting is **11 Mbps**.

```
TX Data rate 0=1, 1=2, 2=5.5, 3=11
4=18, 5=24, 6=36, 7=54 Mbps (3) ? _
```

Note: The XPress DR+W's maximum data rate cannot be selected when **TX Data rate** is set to **auto fallback**.

Enable Power Management

This allows the software to turn off the radio when expecting not to receive or transmit soon. This feature reduces the power consumption by up to 170 mA. Enabling power management increases the response time, because the radio needs to start up again. The radio is enabled to synchronize and check for incoming messages (every 100 ms).

Note: This option is not available when the **Topology** is set to **Adhoc**.

Enable power management <N> ?

Chapter 10: Setup Mode: Advanced Settings

Expert Settings (Option 5)

Note: You can change these settings using Telnet or serial connections only, not on the Web Manager.

Caution: Only a Network Administrator should change these parameters. You must definitely know the consequences the changes might have.

Figure 10-1. Expert Settings

```
TCP Keepalive time in s (1s - 65s; 0s=disable): (45) ?  
ARP Cache timeout in s (1s - 600s) : (600) ?  
Disable Monitor Mode @ bootup (N) ?  
HTTP Port Number : (80) ?  
MTU Size (512 - 1400): (1400) ?  
Enable alternate MAC (N) ?
```

TCP Keepalive time in seconds

This option allows you to change how many seconds the unit waits during a silent connection before attempting to see if the currently connected network device is still on the network. If the unit gets no response, it drops that connection.

```
TCP Keepalive time in s (1s - 65s; 0s=disable): (45)? _
```

ARP Cache timeout in seconds

Whenever the unit communicates with another device on the network, it adds an entry into its ARP table. The **ARP Cache timeout** option allows you to define how many seconds (1-600) the unit will wait before timing out this table.

```
ARP Cache timeout in s (1s - 65s; 0s=disable): (600)? _
```

Disable Monitor Mode at bootup

This option allows you to disable all entries into Monitor Mode during startup, except for the **xxx** sequence. This prevents entry using **yyy**, **zzz**, **xx1**, and **yy1** key sequences (only during the bootup sequence). The default setting for Monitor Mode at bootup is **N** (No). (See [Chapter 12: Monitor Mode](#).)

```
Disable Monitor Mode @ bootup (N) ? _
```

HTTP Port Number

This option allows the configuration of the web server port number. The valid range is 1-65535. The default HTTP port number is **80**.

```
HTTP Port Number : (80) ? _
```

MTU Size

The Maximum Transmission Unit (MTU) is the largest physical packet size a network can transmit for TCP and UDP. Enter between **512** and **1400** bytes. The default setting is **1400** bytes.

```
MTU Size: (1400) ? _
```

Enable alternate MAC

If necessary, enable the alternate MAC address (if specified in the OEM setup record).

```
Enable alternate MAC (N) ? _
```

Security Settings (Option 6)

You can change security settings by means of Telnet or serial connections only, not on the Web Manager. We recommend that you set security over the dedicated network or over the serial setup to prevent eavesdropping.

Caution: *Disabling both Telnet Setup and Port 77FE will prevent users from accessing Setup Mode from the network. Disabling Port 77FE also disables the Web Manager and DeviceInstaller from configuring the device.*

Select **6** to configure security settings.

Figure 10-2. Security Settings

```
Disable SNMP <N> ?
SNMP Community Name <public>:
Disable Telnet Setup <N> ?
Disable TFTP Firmware Update <N> ?
Disable Port 77FEh <N> ?
Disable Web Server <N> ?
Disable Web Setup <N> ?
Disable ECHO ports <Y> ?
Enable Enhanced Password <N> ?
```

Disable SNMP

This setting allows you to disable the SNMP protocol on the unit for security reasons.

Disable SNMP (N) ? _

SNMP Community Name

The SNMP Community Name is a required field for NMS to read or write to a device. Enter a string of 1 to 13 characters.

SNMP Community Name (public): _

The default entry is **public**. The current value is displayed in parentheses.

Disable Telnet Setup

Note: If you choose to disable this option, keep in mind that disabling both **Telnet Setup** and **Port 77FE** will prevent users from accessing Setup Mode from the network.

This setting defaults to the **N** (No) option. The **Y** (Yes) option disables access to Setup Mode by Telnet (port 9999). It only allows access locally using the web pages and the serial port of the unit.

Disable Telnet Setup (N) ? _

Disable TFTP Firmware Upgrade

This setting defaults to the **N** (No) option. The **Y** (Yes) option disables the use of TFTP to perform network firmware upgrades. With this option, you can download firmware upgrades over the serial port using DeviceInstaller's Recover Firmware procedure. (See [Chapter 11: Firmware Upgrades](#) and the DeviceInstaller online Help.

Disable TFTP Firmware Update (N) : _

Disable Port 77FE (Hex)

Note: If you choose to disable this option, keep in mind that disabling both **Telnet Setup** and **Port 77FE** will prevent users from accessing Setup Mode from the network.

Port 77FE is a setting that allows DeviceInstaller, Web Manager, and custom programs to configure the unit remotely. You may wish to disable this capability for security purposes.

Disable Port 77FEh (N) ? _

The default setting is the **N** (No) option, which enables remote configuration. You can configure the unit by using DeviceInstaller, Web Manager, Telnet, or serial configuration.

The **Y** (Yes) option disables remote configuration and web sites.

Note: The **Y** (Yes) option disables many of the GUI tools for configuring the unit, including the embedded Web Manager tool.

Disable Web Server

This setting defaults to the **N** (No) option. The **Y** (Yes) option disables the web server.

Disable Web Server (N) ? _

Disable Web Setup

The **Y** (Yes) option disables configuration using the Web Manager. This setting defaults to the **N** (No) option.

Disable Web Setup (N) ? _

Disable ECHO Ports

This setting controls whether port 7 echoes characters it receives.

Disable ECHO ports (Y) ? _

Enable Enhanced Password

The Enhanced Password setting allows you to set a password of up to 16 characters for protecting Telnet and Web Page access. We recommend that you select the **Y** (Yes) option and enable the enhanced password setting.

Avoid using either the 4 character basic password setting or no password at all as they are not secure options..

Enable Enhanced Password (Y) ? _

Default Settings (Option 7)

Select **7** to reset the unit's channel configuration, email settings, and expert settings to the default settings. The server configuration settings for IP address, gateway IP address, and netmask remain unchanged. The configurable pins' settings also remain unchanged. The specific settings that this option changes are listed below.

Channel 1 and Channel 2 Configuration Settings

Baudrate	9600
I/F Mode	4C (1 stop bit, no parity, 8 bit, RS-232C)
Own TCP port number	Channel 1: 10001 Channel 2: 10002
Connect Mode	C0 (always accept incoming connection; no active connection startup)
Hostlist retry counter	3
Hostlist retry timeout	250 (msec)
Start character for serial channel 1	0x0D (CR)
All other parameters	0

Expert Settings

TCP Keepalive time in s	45
ARP Cache timeout in s	600
Disable Monitor Mode @ bootup	No
HTTP Port Number (1-65535)	80
MTU Size (512 – 1400)	0 (resulting in an operational value of 1400)
Enable alternate MAC	No (for OEM use only)
Ethernet Connection Type	0 (auto-negotiate)

Security Settings

Disable SNMP	No
SNMP community name	public
Disable Telnet setup	No
Disable TFTP Firmware Update	No
Disable Port 77FEh	No
Disable Web Server	No
Disable Web Setup	No
Disable ECHO ports	Yes
Enable Enhanced password	No

WLAN Settings (XPress DR+W only)

Topology	1 (AdHoc)
Network Name	LTRX_IBSS
Channel	11
Security suite	0 (none)
TX Data Rate	0 (fixed)
TX Data Rate	11 Mbps
Enable Power Management	N (No)

Chapter 11: Firmware Upgrades

Obtaining Firmware

You can obtain the most up-to-date firmware and release notes for the unit from the Lantronix web site (www.lantronix.com) or by using anonymous FTP ([ftp.lantronix.com](ftp://lantronix.com)).

Reloading Firmware

There are several ways to update the unit's internal operational code (*.ROM): using DeviceInstaller (the preferred way), using TFTP, or using the serial port. You can also update the unit's internal web interface (*.COB) using TFTP or DeviceInstaller.

Here are *typical* names for those files. Check the Lantronix web site for the latest versions and release notes.

Table 11-1. Firmware Files

ROM File	COB
XDRPL_6101.ROM	XDRPL_WEBM_1402.COB

Please refer to the DeviceInstaller online Help for information about reloading firmware using DeviceInstaller. The other methods are discussed below.

Using TFTP: Graphical User Interface

To download new firmware from a computer:

1. Use a TFTP client to send a binary file to the unit (*.ROM to upgrade the unit's internal operational code and *.COB to upgrade its internal web interface).

Note: TFTP requires the .ROM (binary) version of the unit's internal operational code.

2. In the **TFTP server** field, enter the IP address of the unit being upgraded.
3. Select **Upload** operation and **Binary** format.
4. Enter the full path of the firmware file in the **Local file name** field.
5. In the **Remote file name** field, enter the current internal operational code (**rA** for XPress DR+ or **IA** for XPress DR+W) or **WEB1** for the internal web pages.
6. Click the **Upload Now** button to transfer the file to the unit.

Figure 11-1. TFTP Window

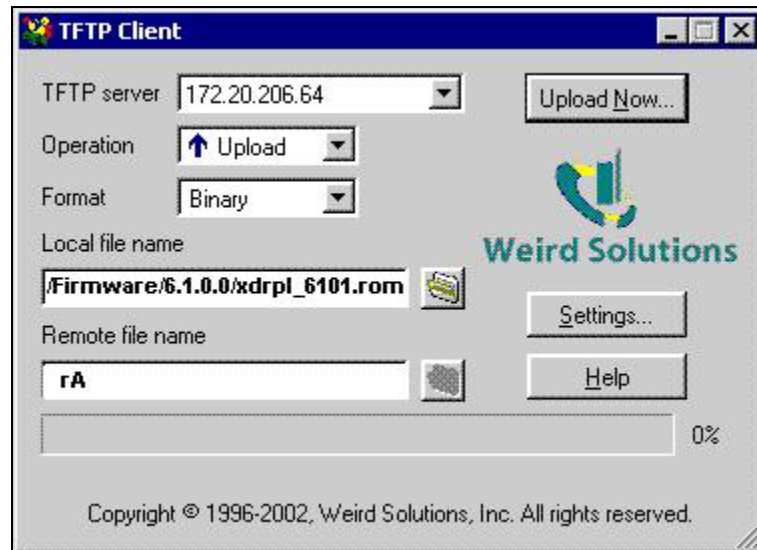

After the firmware has been loaded and stored, which takes approximately 8 seconds to complete, the unit performs a power reset.

Using TFTP: Command Line Interface

To download new firmware from a computer:

1. Enter the following from a TFTP command line interface:

```
tftp -i <ip address> put <local filename> <destination file name>
```

The following examples demonstrate the TFTP command sequence to download the .ROM file and the .COB file:

2. In the **Remote file name** field, enter the current internal operational code (**rA** for XPress DR+ and **IA** for XPress DR+W) or **WEB1** for the internal web pages.

```
tftp -i 192.168.1.111 put xdrpl_6100.rom rA
tftp -i 192.168.1.111 put xdrpl_webm_1402.cob WEB1
```

Recovering the Firmware Using the Serial Port and DeviceInstaller

If for some reason the firmware is damaged, you can recover the firmware file by using DeviceInstaller (v. 4.1.0.7 or later) to download the *.ROM file over the serial port.

To recover firmware:

1. Start DeviceInstaller. If your PC has more than one network adapter, a message displays. Select an adapter and click **OK**.
2. From the **Tools** menu, select **Advanced/Recover Firmware**. The Serial Port Firmware Upgrade window displays.
3. For **Port on PC**, enter the COM port on the PC that is connected to the serial port of the Lantronix unit.

4. For **Device Model**, be sure the appropriate **XPress DR+** device displays.
5. For **Firmware File**, click the **Browse** button and go to the location where the firmware file resides.

Note: Make sure the **XPress DR+** on which you are recovering firmware is connected to this selected port on your PC.

6. Click **OK** to download the file.
7. When prompted, reset the device. Status messages and a progress bar at the bottom of the screen show the progress of the file transfer. When the file transfer completes, the message “Successful, Click OK to Close” appears.
8. Click the **OK** button to complete this procedure.

Note For more information, see *Recovering Firmware in the DeviceInstaller online Help*.

Chapter 12: Monitor Mode

Monitor Mode is a command-line interface used for diagnostic purposes.

There are two ways to enter Monitor Mode: locally using the serial port or remotely using the network.

Entering Monitor Mode Using the Serial Port

To enter Monitor Mode locally:

1. Follow the same steps used for setting the serial configuration parameters (see [Serial Port](#) on page 65).
2. Instead of typing three **x** keys, however:
 - a) Type **zzz** (or **xx1**) to enter Monitor Mode with network connections.
 - b) Type **yyy** (or **yy1**) to enter Monitor Mode without network connections.

A **0>** prompt indicates that you have successfully entered Monitor Mode.

Entering Monitor Mode Using the Network Port

To enter Monitor Mode using a Telnet connection:

1. Establish a Telnet session to the configuration port (9999).
2. Type **M** (upper case). A **0>** prompt indicates that you have successfully entered Monitor Mode.

Figure 12-1. Accessing Monitor Mode

```
Press Enter for Setup Mode
*** NodeSet 2.0 ***
0>_
```

Monitor Mode Commands

The following commands are available in Monitor Mode. Many commands have an IP address as an optional parameter (xxx.xxx.xxx.xxx). If you enter the IP address, the command is applied to another unit with that IP address. If you do not enter the IP address, the command is executed locally.

Note: All commands must be in capital letters.

Table 12-1. Monitor Mode Commands

Command	Command Name	Function
AT	ARP Table	Shows the unit's ARP table entries.
G0, G1, ..., Ge, Gf	Get configuration from memory page	Gets a memory page of configuration information from the device.
GC x.x.x.x	Get Configuration	Gets configuration of unit with IP address x.x.x.x as hex records (120 bytes).
GM	Get MAC address	Shows the unit's 6-byte MAC address.
NC	Network Connection	Shows the unit's IP configuration.
NS	Network Status	Reports the status of the network interfaces, including negotiated parameters like speed/duplex for Ethernet or BSSID, encryption, and authentication for wireless interfaces.
PI x.x.x.x	Ping	Pings unit with IP address x.x.x.x to check device status.
QU	Quit	Exits diagnostics mode.
RS	Reset	Resets the unit's power.
S0, S1, ..., Se, Sf	Set configuration to memory page	Sets a memory page of configuration information on the device.
SA	Scan	Initiates a wireless scan if the wireless interface is enabled at the time. Reports any stations found, including BSSID, SSID, and RSSI. If SA is followed by a string, that string is used to filter SSIDs before reporting. Note: If the BSS does not broadcast its SSID, only the BSSID and RSSI are returned.
SC x.x.x.x	Send Configuration	Sets configuration of unit with IP address x.x.x.x from hex records.
SS	Set Security record	Sets the Security record without the encryption key and length parameters. The entire record must still be written, but the encryption-specific bytes do not need to be provided (they can be null since they are not overwritten).
TT	TCP Connection Table	Shows all incoming and outgoing TCP connections.
VS x.x.x.x	Version	Queries software header record (16 bytes) of unit with IP address x.x.x.x.

Responses to some of the commands are in Intel Hex format.

Note: Entering any of the commands listed above generates one of the following command response codes

Table 7-2. Command Response Codes

Response	Meaning
0>	OK; no error
1>	No answer from remote device
2>	Cannot reach remote device or no answer
8>	Wrong parameter(s)
9>	Invalid command

Chapter 13: Troubleshooting and Technical Support

This chapter discusses how you can diagnose and fix errors quickly without having to contact a dealer or Lantronix. It helps to connect a terminal to the serial port while diagnosing an error to view summary messages that may display. When troubleshooting, always ensure that the physical connections (power cable, network cable, and serial cable) are secure.

Note: Some unexplained errors might be caused by duplicate IP addresses on the network. Make sure that your unit's IP address is unique.

When troubleshooting the following problems, make sure that the unit is powered up. Confirm that you are using a good network connection.

Problems and Error Messages

Note: For information about diagnostic LEDs, see page 26.

Table 13-1. Problems and Error Messages

Problem/Message	Reason	Solution
When you issue the ARP -S command in Windows, the "ARP entry addition failed: 5" message displays.	Your currently logged-in user does not have the correct rights to use this command on this PC.	Have someone from your IT department log you in with sufficient rights.
When you attempt to assign an IP address to the unit by the ARP method, the "Press Enter to go into Setup Mode" error "(described below) message displays. Now when you Telnet to the device server, the connection fails.	When you Telnet to port 1 on the device server, you are only assigning a temporary IP address. When you Telnet into port 9999 and do not press Enter quickly, the device server reboots, causing it to lose the IP address.	Telnet back to port 1. Wait for it to fail, then Telnet to port 9999 again. Make sure you press Enter quickly.
When you Telnet to port 9999, the "Press Enter to go into Setup Mode" message displays. However, nothing happens when you press Enter , or your connection closes.	You did not press Enter quickly enough. You only have 5 seconds to press Enter before the connection closes.	Telnet to port 9999 again, but press Enter as soon as you see the "Press Enter to go into Setup Mode" message.

Problem/Message	Reason	Solution
<p>When you Telnet to port 1 to assign an IP address to the device server, the Telnet window does not respond for a long time.</p>	<p>You may have entered the Ethernet address incorrectly with the ARP command.</p>	<p>Confirm that the Ethernet address that you entered with the ARP command is correct. The Ethernet address may only include numbers 0-9 and letters A-F. In Windows and usually in Unix, the segments of the Ethernet address are separated by dashes. In some forms of Unix, the Ethernet address is segmented by colons.</p>
	<p>The IP address you are trying to assign is not on your logical subnet.</p>	<p>Confirm that your PC has an IP address and that it is in the same logical subnet that you are trying to assign to the device server.</p>
	<p>The device server may not be plugged into the network properly.</p>	<p>Make sure that the Link LED is lit. If the Link LED is not lit, then the device server is not properly plugged into the network.</p>
<p>When you try to assign an IP with DeviceInstaller, you get the following :</p> <p>"No response from device! Verify the IP, Hardware Address and Network Class. Please try again."</p>	<p>The cause is most likely one of the following:</p> <p>The hardware address you specified is incorrect.</p> <p>The IP address you are trying to assign is not a valid IP for your logical subnet.</p> <p>You did not choose the correct subnet mask.</p>	<p>Double-check the parameters that you specified.</p> <p>Note: You cannot assign an IP address to a device server through a router.</p>
<p>The device server is not communicating with the serial device to which it is attached.</p>	<p>The most likely reason is the wrong serial settings were chosen.</p>	<p>The serial settings for the serial device and the device server must match. The default serial settings for the device server are RS-232, 9600 baud, 8 character bits, no parity, 1 stop bit, no flow control.</p>
<p>When you try to enter the setup mode on the device server using the serial port, you get no response.</p>	<p>The issue is most likely something covered in the previous problem, or possibly, you have Caps Lock on.</p>	<p>Double-check everything in the problem above. Confirm that Caps Lock is not on.</p>

Problem/Message	Reason	Solution
<p>You can ping the device server, but not Telnet to the device server on port 9999.</p>	<p>There may be an IP address conflict on your network</p> <p>You are not Telnetting to port 9999.</p> <p>The Telnet configuration port (9999) is disabled within the device server security settings.</p>	<p>Turn the device server off and then issue the following commands at the DOS prompt of your computer:</p> <p>ARP -D X.X.X.X (X.X.X.X is the IP of the device server).</p> <p>PING X.X.X.X (X.X.X.X is the IP of the device server).</p> <p>If you get a response, then there is a duplicate IP address on the network. If you do not get a response, use the serial port to verify that Telnet is not disabled.</p>
<p>The device server appears to be set up correctly, but you are not communicating with your device attached to the device server across the network.</p>	<p>If you are sure that the serial port setting is correct, then you may not be connecting to the correct socket of the device server.</p> <p>Another possibility is that the device server is not set up correctly to make a good socket connection to the network.</p>	<p>Use the Connect Mode option C0 for making a connection to the device server from the network. Use Connect Mode option C1 or C5 for a connection to the network from the device server.</p>
<p>When connecting to the Web Manager within the device server, the "No Connection With The Device Server" message displays.</p>	<p>Your computer is not able to connect to port 30718 (77FEh) on the device server.</p>	<p>Make sure that port 30718 (77FEh) is not blocked with any router that you are using on the network. Also, make sure that port 77FEh is not disabled within the Security settings of the device server.</p>

Technical Support

Lantronix offers many resources to support our customers and products at <http://www.lantronix.com/support>. For instance, ask a question, find firmware downloads, access the FTP site and search through tutorials, FAQs, bulletins, warranty information, extended support services, and product documentation.

To contact technical support or sales, look up your local office at <http://www.lantronix.com/about/contact.html>. When you report a problem, please provide the following information:

- ◆ Your name, company name, address, and phone number
- ◆ Lantronix product and model number
- ◆ Lantronix MAC number or serial number
- ◆ Firmware version and current configuration
- ◆ Description of the problem
- ◆ Status of the unit when the problem occurred (please try to include information on user and network activity at the time of the problem).

Appendix A: Technical Specifications

Table A-1. XPress DR+ and XPress DR+W Specifications

Category	Description
CPU	Lantronix DSTNI-EX 48 MHz clock
Internal CPU Memory	256 KB SRAM
Flash	2 MB Flash
EEPROM	2 KB EEPROM
Serial Interface	2 RJ45 RS232 Serial Ports Baud rate selectable from 300 to 230 Kbaud 1 Screw terminal RS-422/485 interface on Serial Port 2 (2 and 4 wire support) LED indicators for TXD and RXD activities
Serial Line Formats	Characters: 7 or 8 data bits Stop bits: 1 or 2 Parity: odd, even, none
Modem Control	DTR, DSR
Flow Control	Hardware: CTS/RTS Software: XON/XOFF
Reset (warm boot)	Front panel recessed push button. (This is not a reset to factory settings.)
Power Input	Removable screw terminal block connector 9-30 VDC or 9-24 VAC with chassis ground 2.3 Watts maximum
Network Interface	2 RJ45 10Base-T/100Base-TX Ethernet ports Embedded unmanaged fully compliant 802.3u non-blocking Ethernet switch Store and forward architecture with 1K MAC address lookup table Automatic MDI/MDI-X crossover Full duplex IEEE 802.3x flow control Half-duplex back pressure flow control IEEE 802.1d spanning tree
Dimensions	123 x 57 x 88 mm (4.85 x 2.25 x 3.45 in), terminal blocks included
Weight	0.21 kg (0.46 lb)
Temperature	Operating range: -40°C to +70° C (-40 to 158 degrees F)
Humidity	20% to 90% relative humidity, non-condensing
Case	High-impact plastic case with integrated DIN-rail (35 mm) mount IP30 enclosure rating
Protocols Supported	ARP, UDP/IP, TCP/IP, Telnet, ICMP, SNMP, DHCP, BOOTP, TFTP, and HTTP
Installable Industrial Protocols	ModBus TCP, ModBus ASCII/RTU, Multi-Master DF1
Management	Internal web server (Standard Tunneling firmware only) SNMP (read only) Serial login Telnet login DeviceInstaller software
System Software	DeviceInstaller, Windows® 95/98/ME/NT/2000/XP-based configuration software

Category	Description
	Com Port Redirector, Windows® 98/NT/2000/XP-based virtual com port software
LEDs	TX/RX activity per serial Link/Activity per Ethernet port Power/System OK Wireless
Isolation	8 KV direct contact, 15 KV air discharge, ESD protection on all serial ports (IEC 1000-4-2, IEC 61000-4-2) 2 K VAC / 2.8K VDC galvanic isolation between power input port to Ethernet ports (except chassis ground) 2 K VAC / 2.8K VDC galvanic isolation between power input port to serial ports Transient Voltage protection and ESD with max non-repetitive surge current 800 A (8/20 us) (IEC 61000-4-2) 2 K VAC / 2.8K VDC galvanic isolation between Ethernet ports (except chassis ground) 2 K VAC / 2.8K VDC galvanic isolation between Ethernet ports to serial ports 40 A (5/50 ns) EFT protection (IEC 61000-4-4), 12 A (8/20 us) lightning protection (IEC 61000-4-5) on all Ethernet ports
Agency Approvals	UL, CSA, FCC, CE, TUV, cTick, VCCI

Table A-2. XPress DR+W Wireless Specifications

Category		IEEE 802.11b/g
Frequency Range		2.412 – 2.484 GHz
Output Power		14 +/- 1.0 dBm <= 12 Mbps 12 +/- 1.0 dBm > 12 Mbps
Antenna Connector		1
Data Rates		1*,2*,5.5*,11*,6,9,12,18*,24*,36*,48,54* Mbps
Radio	Number of Selectable Subchannels**	US 1-11 CA 1-11 JP 1-14 FR 10-13 SP 10-11 OT 1-13 (OT=Others)
	Modulation	DSSS,DBPSK,DQPSK,CCK, OFDM, 16QAM, 64QAM
	Antenna Connector	1
Security		WEP 64/128,WPA
Maximum Receive Level		10 dBm (with PER < 8%)
Receiver Sensitivity		72 dBm for 54 Mbps 87 dBm for 11 Mbps 89 dBm for 5.5 Mbps 90 dBm for 2.0 Mbps 92 dBm for 1.0 Mbps

Appendix B: Lantronix Cables and Adapters

Lantronix P/N	Description	Applications
500-103	6' RJ45-to DB9F	<p>Included with XPress DR+ for setup or device connectivity.</p> <p>Connects the RJ45 RS232 serial ports of XPress DR+ to a DB9M DTE interface of a PC or serial device.</p>
200.2062	Cable Ethernet CAT5; RJ45, 2 m (6.6 ft)	<p>Connects the XPress DR+ Ethernet ports to an Ethernet switch/hub or is used for cascading from one XPress DR+ to another.</p> <p>Connects the XPress DR+ serial RJ45 RS232 ports to a device using one of the adapters listed below.</p>
200.2063	Cable Ethernet CAT5; RJ45, 5 m (16.4 ft)	<p>Connects the XPress DR+ Ethernet ports to an Ethernet switch/hub or is used for cascading from one XPress DR+ to another.</p> <p>Connects the XPress DR+ serial RJ45 RS232 ports to a device using one of the below listed adapters.</p>
200.2064	Cable Ethernet CAT5; RJ45, 10 m (32.8 ft)	<p>Connects the XPress DR+ Ethernet ports to an Ethernet switch/hub or is used for cascading from one XPress DR+ to another.</p> <p>Connects the XPress DR+ serial RJ45 RS232 ports to a device using one of the adapters listed below.</p>
200.2065	Cable Ethernet CAT5; RJ45, 15 m (49.2 ft)	<p>Connects the XPress DR+ Ethernet ports to an Ethernet switch/hub or is used for cascading from one XPress DR+ to another.</p> <p>Connects the XPress DR+ serial RJ45 RS232 ports to a device using one of the adapters listed below.</p>
200.2066A	Adapter RJ45-to-DB25M	Allows a standard straight-pinned CAT5 cable to connect the XPress DR+ RJ45 serial ports to the DB25F DCE interface of a serial device.
200.2067A	Adapter RJ45-to-DB25F	Allows a standard straight-pinned CAT5 cable to connect the XPress DR+ RJ45 serial ports to the DB25M DTE interface of a serial device.
200.2069A	Adapter RJ45-to-DB9M	Allows a standard straight-pinned CAT5 cable to connect the XPress DR+ RJ45 serial ports to the DB9F DCE interface of a serial device.
200.2070A	Adapter RJ45-to-DB9F	Allows a standard straight-pinned CAT5 cable to connect the XPress DR+ to the DB9M DTE interface of a PC or serial device.

Appendix C: Alternative Methods of Assigning an IP Address

Earlier chapters describe how to assign a static IP address using DeviceInstaller, Web-Manager, and Setup Mode (through a Telnet or serial connection). This section covers other methods for assigning an IP address over the network.

DHCP

The unit ships with a default IP address of 0.0.0.0, which automatically enables DHCP. If a DHCP server exists on the network, it provides the unit with an IP address, gateway address, and subnet mask when the unit boots up.

You can use the DeviceInstaller software (if applicable) to search the network for the DHCP-assigned IP address and add it to the list of devices retrieved.

Note: This DHCP address does **not** appear in the unit's Setup Mode or in Web Manager. You can determine your unit's DHCP-assigned IP address in Monitor Mode. When you enter Monitor Mode from the serial port with network connection enabled and issue the **NC** (Network Communication) command, you see the unit's IP configuration.

AutoIP

The unit ships with a default IP address of 0.0.0.0, which automatically enables Auto IP within the unit. AutoIP is an alternative to DHCP that allows hosts to obtain an IP address automatically in smaller networks that may not have a DHCP server. A range of IP addresses (from 169.254.0.1 to 169.254.255.1) has been explicitly reserved for AutoIP-enabled devices. Do not use this range of Auto IP addresses over the Internet.

- ◆ If your unit cannot find a DHCP server, and you have not manually assigned an IP address to it, the unit automatically selects an address from the AutoIP reserved range. Then, your unit sends out a (ARP) request to other nodes on the same network to see whether the selected address is being used.
- ◆ If the selected address is not in use, the unit uses it for local subnet communication.□□
- ◆ If another device is using the selected IP address, the unit selects another address from the AutoIP range and reboots. After reboot, the unit sends out another ARP request to see if the selected address is in use, and so on.

AutoIP does not replace DHCP. The unit continues to look for a DHCP server on the network. If it finds a DHCP server, the unit switches to the DHCP server-provided address and reboots.

Note: If a DHCP server is found, but it denies the request for an IP address, the unit does not attach to the network, but waits and retries.

You can disable AutoIP by setting the unit's IP address to **0.0.1.0**. This setting enables DHCP but disables AutoIP.

BOOTP

Similar to DHCP, but for smaller networks. Automatically assigns the IP address for a specific duration of time.

ARP and Telnet

If the unit has no IP address, you can use Address Resolution Protocol (ARP).

To assign a temporary IP address:

1. On a UNIX or Windows-based host, create an entry in the host's ARP table using the intended IP address and the hardware address of the unit (on the product label on the bottom of the unit).

```
arp -s 191.12.3.77 00:20:4a:xx:xx:xx
```

Note: For the ARP command to work on Windows 95, the ARP table on the PC must have at least one IP address defined other than its own.

2. If you are using Windows 95, type **ARP -A** at the DOS command prompt to verify that there is at least one entry in the ARP table. If the local machine is the only entry, ping another IP address on your network to build a new entry in the ARP table; the IP address must be a host other than the machine on which you are working. Once there is at least one additional entry in the ARP table, use the following command to ARP an IP address to the unit:

```
arp -s 191.12.3.77 00-20-4a-xx-xx-xx
```

3. Open a Telnet connection to port 1. The connection fails quickly, but the unit temporarily changes its IP address to the one designated in this step.

```
telnet 191.12.3.77 1
```

4. Open a Telnet connection to port 9999, and press **Enter** within **five seconds** to go into Setup Mode. If you wait longer than five seconds, the unit reboots.

```
telnet 191.12.3.77 9999
```

Note: The IP address you just set is temporary and reverts to the default value when the unit's power is reset, unless you configure the unit with a static IP address and store the changes permanently.

Appendix D: Binary to Hexadecimal Conversions

Many of the unit's configuration procedures require you to assemble a series of options (represented as bits) into a complete command (represented as a byte). The resulting binary value must be converted to a hexadecimal representation.

Converting Binary to Hexadecimal

Following are two simple ways to convert binary numbers to hexadecimal notation.

Conversion Table

Hexadecimal digits have values ranging from 0 to F, which are represented as 0-9, A (for 10), B (for 11), etc. To convert a binary value (for example, 0100 1100) to a hexadecimal representation, treat the upper and lower four bits separately to produce a two-digit hexadecimal number (in this case, 4C). Use the following table to convert values from binary to hexadecimal.

Decimal	Binary	Hex	Decimal	Binary	Hex
0	0000	0	8	1000	8
1	0001	1	9	1001	9
2	0010	2	10	1010	A
3	0011	3	12	1100	C
4	0100	4	13	1101	D
5	0101	5	14	1110	E
6	0110	6	15	1111	F
7	0111	7			

Scientific Calculator

Another simple way to convert binary to hexadecimals is to use a scientific calculator, such as the one available on Windows' operating systems. For example:

1. On the Windows' **Start** menu, click **Programs**→**Accessories**→**Calculator**.
1. On the **View** menu, select **Scientific**. The scientific calculator displays.
2. Click **Bin** (Binary), and type the number you want to convert.

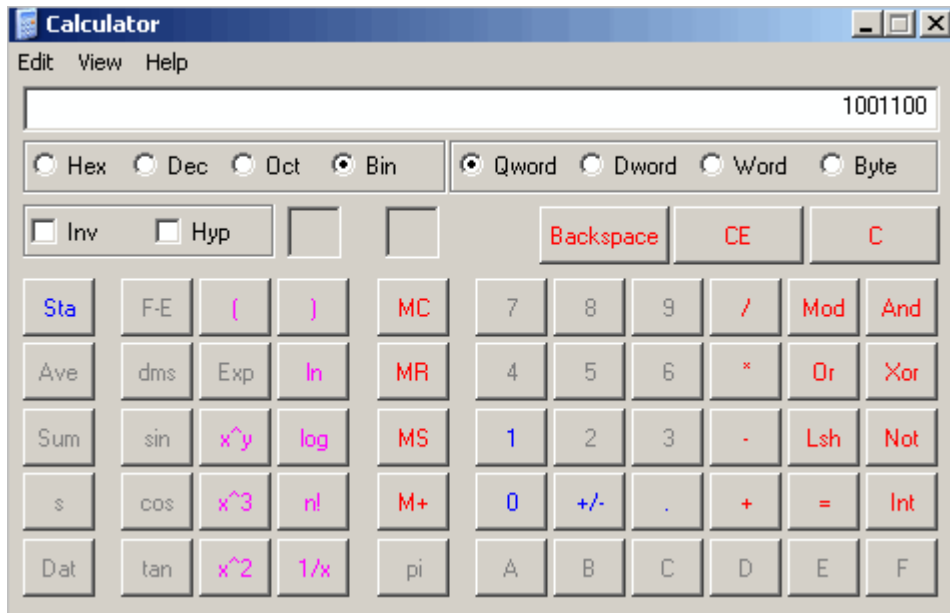

3. Click **Hex**. The hexadecimal value displays.

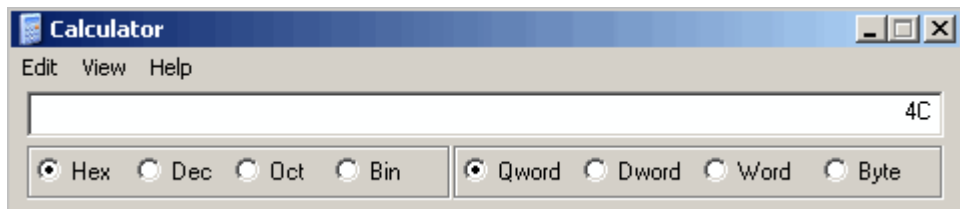

Appendix E: Compliance Information

Declaration of Conformity

(according to ISO/IEC Guide 22 and BS 7514)

Manufacturer's Name & Address

Lantronix, 15353 Barranca Parkway, Irvine, CA 92618 USA

Declares that the following product:

Product Name Model

XPress DR+ and XPress DR+W

Description

2-Port Industrial Device Server and Wireless 2-Port Industrial Device Server

Conforms to the following standards or other normative documents:

Safety

UL 60950-1

CSA 22.2. No 60950-1-03

EN 60950-1

Table E-1. Electromagnetic Emissions and Immunity – XPress DR+

ITE	
Emissions:	Immunity:
FCC Part 15 Subpart B Class A	EN55024: 1998 +A1: 2001 +A2: 2003
ICES-003 Issue 4 February 2004 Class A	IEC_61000-4-2: 1995
AS/NZS CISPR 22: 2004 Class A	IEC_61000-4-3: 1995
EN55022: 1998 + A1: 2000 + A2: 2003 CLASS A	IEC_61000-4-4: 1995
EN61000-3-2: 2000 Class A	IEC_61000-4-5: 1995
EN61000-3-3: 1995 +A1: 2001	IEC_61000-4-6: 1996
	IEC_61000-4-8: 1993
	IEC_61000-4-11: 1994

Industrial Environment	
Emissions:	Immunity
FCC Part 18 Subpart C ICES-001 Issue 4 July 2004 EN61000-6-4: 2001 and AS/NZS 4251.2: 1999 CISPR11	EN61000-6-2: 2001 and AS/NZS 61000.6.2: 2002 IEC_61000-4-2: 1995 IEC_61000-4-3: 1995 IEC_61000-4-4: 1995 IEC_61000-4-5: 1995 IEC_61000-4-6: 1996 IEC_61000-4-8: 1993 IEC_61000-4-11: 1994

Table E-2. Electromagnetic Emissions and Immunity – XPress DR+W

ITE	
Emissions:	Immunity:
CFR Title 47 FCC Part 15, Subpart B and C, Class B Industry Canada ICES-003 Issue 4 (2004) Class B EN 301 489-1 v1.4.1 (2002-08), EMC Directive (1999/5/EC) EN 301 489-17 v1.2.1 (2002-08), EMC Directive (1999/5/EC) Australia/New Zealand AS/NZS CISPR 22 (2006), Class B EN55022: 1998 + A1: 2000 + A2: 2003 EN61000-3-2: 2000 + A2: 2005 EN61000-3-3: 1995 + A1: 2001 RSS-210 Issue 6 (2005) RSS-GEN Issue 1 (2005)	EN 301 489-1 v1.4.1 (2002-08), EMC Directive (1999/5/EC) EN 301 489-17 v1.2.1 (2002-08), EMC Directive (1999/5/EC) EN55024: 1998 + A1: 2001 + A2: 2003

Radio

EN 300 328 v1.4.1 (2003-04), R&TTE Directive (1999/5/EC)

Australia/New Zealand AS/NZS 4771 (2000 + A1:2003)

Supplementary Information

This Class A digital apparatus complies with Canadian ICES-003 (CSA) and has been verified as being compliant within the Class A limits of the FCC Radio Frequency Device Rules (FCC Title 47, Part 15, Subpart B CLASS A), measured to CISPR 22: 1993 limits and methods of measurement of Radio Disturbance Characteristics of Information Technology Equipment. The product complies with the requirements of the Low Voltage Directive 72/23/EEC and the EMC Directive 89/336/EEC.

Manufacturer's Contact

Director of Quality Assurance, Lantronix
7535 Irvine Center Drive, Suite 100
Irvine, CA 92618, USA CA 92618 USA

Toll Free: 800-526-8766
Phone: 949-453-3990
Fax: 949-453-3995

XPress DR+W Regulatory Information

USA Federal Communications Commission (FCC) Notice

This device complies with part 15 of the FCC Rules. Operation is subject to the following two conditions:

This device may not cause harmful interference, and

This device must accept any interference received, including interference that may cause undesired operation.

Caution: *Changes or modifications to this product not expressly approved by Lantronix could void the user's authority to operate this equipment.*

Note: *This equipment has been tested and found to comply with the limits for a Class B digital device, pursuant to part 15 of the FCC Rules. These limits are designed to provide reasonable protection against harmful interference in a residential installation. This equipment generates, uses, and can radiate radio frequency energy and, if not installed and used in accordance with the instructions, may cause harmful interference to radio communications. However, there is no guarantee that interference will not occur in a particular installation.*

If this equipment does cause harmful interference to radio or television reception, which can be determined by turning the equipment off and on, the user is encouraged to try to correct the interference by one or more of the following measures:

- ◆ Reorient or relocate the receiving antenna.
- ◆ Increase the separation between the equipment and receiver.
- ◆ Connect the equipment into an outlet on a circuit different from that to which the receiver is connected.
- ◆ Consult the dealer or an experienced radio/TV technician for help.

Caution: *Exposure to Radio Frequency Radiation*

*The equipment contains transmitter with FCC ID: **R68XSDRWLSG***

The antenna(s) used for this transmitter must be installed to provide a separation distance of at least 20 cm from all persons and must not be co-located or operating in conjunction with any other antenna or transmitter. Installers and end-users must be provided with antenna installation instructions and transmitter operating conditions for satisfying RF exposure compliance.

Canada – Industry Canada Notice

This device complies with Industry Canada RSS-210 regulations (**IC: 3867A-XSDRWLSG**). Operation is subject to the following two conditions:

- ◆ This device may not cause interference, and
- ◆ This device must accept any interference, including interference that may cause undesired operation of the device.

To prevent radio interference to the licensed service, this device must be operated indoors only and should be kept away from windows to provide maximum shielding.

This Class B digital apparatus complies with Canadian ICES-003." Cet appareil numérique de la classe B est conforme à la norme NMB- 003 du Canada.

Antenna Notice:

This device has been designed to operate with an antenna having a maximum gain of 3 dBi. Antenna having a higher gain is strictly prohibited per regulations of Industry Canada. The required antenna impedance is 50 ohms.

To reduce potential radio interference to other users, the antenna type and its gain should be so chosen that the equivalent isotropically radiated power (EIRP) is not more than that required for successful communication.

Exposure of Humans to RF Fields

The installer of this radio equipment must ensure that the antenna is located or pointed such that it does not emit RF field in excess of Health Canada limits for the general population; consult Safety Code 6, obtainable from Health Canada's website: www.hc-sc.gc.ca/rpb

RoHS, REACH and WEEE Compliance Statement

Please visit <http://www.lantronix.com/legal/rohs/> for Lantronix's statement about RoHS, REACH and WEEE compliance.

Europe – R&TTE Directive 99/5/EC, Wireless Notice

This product is designated as a Class 2 type radio device that utilizes non-harmonized frequencies and power levels for Europe. It is marked with the following warning symbol to bring to your attention to the fact it might not be legal to use this product in every country. In most cases this product has already been granted permission for use from individual countries in Europe. If you are unsure, please contact the communications authority for the country to be operated in.



In addition to this notice, the following countries in Europe have certain restrictions on the operation of 2.4 GHz WLAN type devices:

Country	Restriction
France	Outdoor use is limited to 10mW E.I.R.P within the frequency band 2454-2483.5 MHz.
Italy	If used outside of own premises, general authorization is required
Luxembourg	General authorization required for public service.
Romania	Individual license is required.

Australia & New Zealand – Wireless Notice

This product has been found to be compliant with the wireless regulatory requirements for Australia and New Zealand and is designated to have met Compliance Level 2.

The compliance mark is designated with the circle and check mark inside is called the “C-Tick” mark. This C-Tick mark label is located underneath this product and signifies its compliance, as shown below:



ACN 095 223 484

The number “ ACN 095 223 484 “ stands for Australian Company Number and the 9 digit number designates the local representative in Australia who can take inquiries regarding this product’s compliance status. The following contact address is found below:

Lantronix Australia Pty. Ltd.
 c/o LLK Chartered Accountants
 Suite 2, Level 7
 122 Walker Street
 North Sydney, NSW 2060
 Australia