

MAXIM

Low Power Fast CMOS Analog Switches

IH5140/41/42/43/44/45

General Description

The IH5140 family consists of six CMOS analog switches that are intended for high speed general purpose applications. These switches are latch-up proof, break-before-make single and dual versions of all the popular switch formats — SPST, SPDT, and DPST. Key features of the family include toggle rates in excess of 1MHz, t_{ON} times of 80ns typical and t_{OFF} times of 50ns. OFF leakage current is less than 100pA maximum at +25°C and quiescent currents are 1μA maximum, making the switches ideal for portable equipment.

Maxim has significantly improved the design of these switches versus the original manufacturer. Maxim's switches are guaranteed to operate from ±4.5V to ±18V, and will switch input signals that include the supplies.

Applications

- High Speed Test Equipment
- Sample and Hold Circuits
- Guidance and Control Systems
- Radar Systems
- Aircraft Head-Up Displays
- Military Radios

Typical Operating Circuit

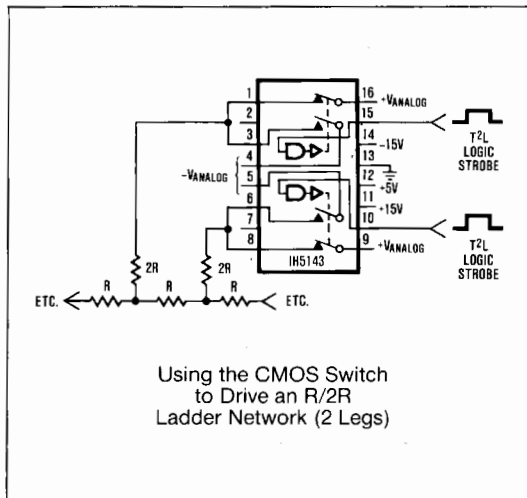

Features

- ◆ Pin for Pin 2nd Source!
- ◆ Break-Before-Make Switching Action
- ◆ Fast t_{ON} (80ns typ.) and t_{OFF} (50ns)
- ◆ Input Signal Range Includes Supply Rails
- ◆ Guaranteed ±4.5V to ±18V Operation
- ◆ Low OFF Leakage Current — 100pA max.
- ◆ Greater than 1MHz Toggle Rate
- ◆ TTL and CMOS Compatible

Ordering Information

PART	TEMP. RANGE	PACKAGE
SINGLE POLE SINGLE THROW (SPST)		
IH5140C/D	0°C to +70°C	DICE
IH5140CJE	0°C to +70°C	16 Lead CERDIP
IH5140CPE	0°C to +70°C	16 Lead Plastic DIP
IH5140CWE	0°C to +70°C	16 Lead Wide SO
IH5140M/D	-55°C to +125°C	DICE
IH5140MJE	-55°C to +125°C	16 Lead CERDIP
DUAL SINGLE POLE SINGLE THROW (DUAL SPST)		
IH5141C/D	0°C to +70°C	DICE
IH5141CJE	0°C to +70°C	16 Lead CERDIP
IH5141CPE	0°C to +70°C	16 Lead Plastic DIP
IH5141CTW	0°C to +70°C	10 Lead Metal Can
IH5141CWE	0°C to +70°C	16 Lead Wide SO
IH5141M/D	-55°C to +125°C	DICE
IH5141MJE	-55°C to +125°C	16 Lead CERDIP
IH5141MTW	-55°C to +125°C	10 Lead Metal Can
SINGLE POLE DOUBLE THROW (SPDT)		
IH5142C/D	0°C to +70°C	DICE
IH5142CJE	0°C to +70°C	16 Lead CERDIP
IH5142CPE	0°C to +70°C	16 Lead Plastic DIP
IH5142CWE	0°C to +70°C	16 Lead Wide SO
IH5142M/D	-55°C to +125°C	DICE
IH5142MJE	-55°C to +125°C	16 Lead CERDIP
DUAL SINGLE POLE DOUBLE THROW (DUAL SPDT)		
IH5143C/D	0°C to +70°C	DICE
IH5143CJE	0°C to +70°C	16 Lead CERDIP
IH5143CPE	0°C to +70°C	16 Lead Plastic DIP
IH5143CWE	0°C to +70°C	16 Lead Wide SO
IH5143M/D	-55°C to +125°C	DICE
IH5143MJE	-55°C to +125°C	16 Lead CERDIP

(Ordering information continued on fourth page.)

Low Power Fast CMOS Analog Switches

ABSOLUTE MAXIMUM RATINGS

Current (Any Terminal)	< 30mA	$V_D - V^-$	< 30V
Storage Temperature	-65°C to +150°C	$V_D - V_S$	< ±22V
Operating Temperature	-55°C to +125°C	$V_L - V^-$	< 33V
Power Dissipation	450mW	$V_L - V_{IN}$	< 30V
(All Leads Soldered to a P.C. Board)		$V_L - GND$	< 20V
Derate 6mW/°C Above +70°C		$V_{IN} - GND$	< 20V
Lead Temperature (Soldering, 10 sec)	300°C	Digital Inputs	($V^+ + 0.3V$) to ($V^+ - 38V$)
Voltages		V_S or V_D	-0.3V to ($V^+ + 0.3V$) (Note 1)
$V^+ - V^-$	< 38V		
$V^+ - V_D$	< 30V		

Note 1: Signals on S, D and digital inputs which exceed V^- or V^+ will be clamped by internal diodes. Limit forward diode current to 30mA maximum.

Stresses above those listed under "Absolute Maximum Ratings" may cause permanent damage to the device. These are stress ratings only and functional operation of the device at these or any other conditions above those indicated in the operational sections of the specifications is not implied. Exposure to absolute maximum rating conditions for extended periods may affect device reliability.

ELECTRICAL CHARACTERISTICS

(All Parameters with $V^+ = +15V$, $V^- = -15V$, $V_L = +5V$, unless otherwise indicated)

PARAMETER	SYMBOL	TEST CONDITIONS	MIN./MAX. LIMITS						UNITS
			MILITARY			COMMERCIAL			
			-55°C	+25°C	+125°C	0°C	+25°C	+70°C	
Input Logic Current	I_{INH}	$V_{IN} = 2.4V$ (Note 2)	±1	±1	10	+1	±1	10	μA
Input Logic Current	I_{INL}	$V_{IN} = 0.8V$ (Note 2)	+1	±1	10	±1	±1	10	μA
Drain-Source On Resistance	$r_{DS(ON)}$	$I_S = -10mA$ $V_{ANALOG} = -10V$ to +10V	50	50	75	75	75	100	Ω
Channel to Channel $r_{DS(ON)}$ Match	$\Delta r_{DS(ON)}$		3 (typ)			5 (typ)			Ω
Minimum Analog Signal Handling Capability	V_{ANALOG}		+15			±15			V
Switch OFF Leakage Current	$I_{D(OFF)}$ + $I_{S(OFF)}$	$V_D = +10V, V_S = -10V$ $V_D = -10V, V_S = +10V$	±0.5	±0.5	100	±5	±5	100	nA
Switch ON Leakage Current	$I_{D(ON)}$ + $I_{S(ON)}$	$V_D = V_S = -10V$ to +10V	±1	±1	200	+2	+2	200	nA
Switch "ON" Time Switch "OFF" Time	t_{ON} t_{OFF}		See switching time specifications and timing diagrams.						
Charge Injection	$Q_{(INJ)}$	(Note 3)	10 (typ)			15 (typ)			pC
Minimum Off Isolation Rejection Ratio	OIRR	$f = 1MHz, R_L = 100\Omega,$ $C_L \leq 5pF$ (Note 3)	54 (typ)			50 (typ)			dB
+ Power Supply Quiescent Current	I^+	$V^+ = +15V, V^- = -15V,$ $V_L = +5V$	1.0	1.0	10.0	10	10	100	μA
- Power Supply Quiescent Current	I^-		-1.0	-1.0	-10.0	-10	-10	-100	μA
+5V Supply Quiescent Current	I_L		1.0	1.0	10.0	10	10	100	μA
Ground Supply Quiescent Current	I_{GND}		1.0	1.0	10.0	10	10	100	μA
Minimum Channel to Channel Cross Coupling Rejection Ratio	CCRR	One Channel Off (Note 3)	54 (typ)			50 (typ)			dB
Power Supply Range for Continuous Operation	V_{OP}	(Note 4)	±4.5 (min) ±18V (max)			±4.5 (min) ±18V (max)			V

Note: 2. Some channels are turned on by high (1) logic inputs and other channels are turned on by low (0) inputs; however, 0.8V to 2.4V describes the minimum range for switching properly. Refer to logic diagrams to find logical value of logic input required to produce ON or OFF state.

3. Typical values are for design aid only, not guaranteed and not subject to production testing.

4. Electrical characteristics, such as ON Resistance, will change when power supplies, other than ±15V, are used.

Low Power Fast CMOS Analog Switches

IH5140/41/42/43/44/45

SWITCHING TIME SPECIFICATIONS

(t_{on} , t_{off} are maximum specifications and $t_{on-t_{off}}$ is minimum specifications)

PART NUMBER	CHARACTERISTICS	SYMBOL	TEST CONDITIONS	MILITARY			COMMERCIAL			UNITS
				-55°C	+25°C	+125°C	0°C	+25°C	+70°C	
IH5140-5141	Switch "ON" time	t_{on}	Figure 1		100*			150		ns
	Switch "OFF" time	t_{off}			75*			125		
	Break-before-make	$t_{on-t_{off}}$			10* TYP			5		
IH5142-5143	Switch "ON" time	t_{on}	Figure 1		175*			250		ns
	Switch "OFF" time	t_{off}			125*			150		
	Break-before-make	$t_{on-t_{off}}$		10* TYP			5			
	Switch "ON" time	t_{on}	Figure 2		200			300		ns
Switch "OFF" time	t_{off}			125			150			
Break-before-make	$t_{on-t_{off}}$			10* TYP			5			
IH5144-5145	Switch "ON" time	t_{on}	Figure 3		175*			250		ns
	Switch "OFF" time	t_{off}			125*			150		
	Break-before-make	$t_{on-t_{off}}$		10* TYP			5			
	Switch "ON" time	t_{on}	Figure 4		200			300		ns
Switch "OFF" time	t_{off}			125			150			
Break-before-make	$t_{on-t_{off}}$			10* TYP			5			

Note: Switching times are measured at 90% points.

* Guaranteed but not subjected to production testing.

Switching Time Test Circuits

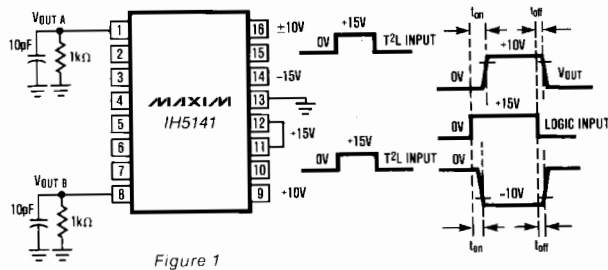

Figure 1

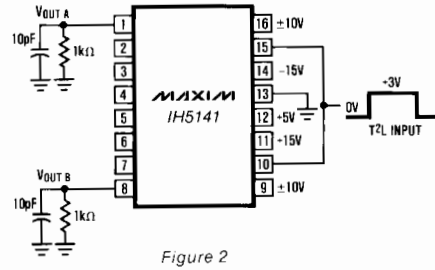

Figure 2

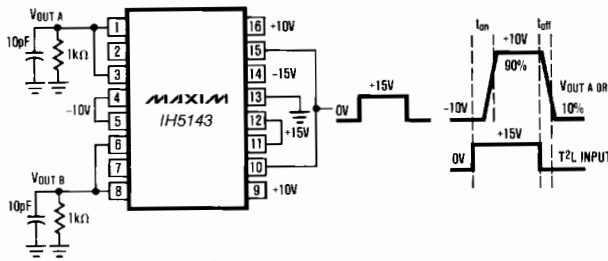

Figure 3

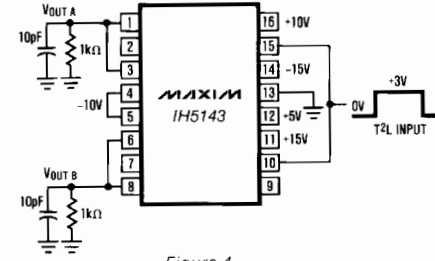

Figure 4

Low Power Fast CMOS Analog Switches

Pin Configuration and Switching State Diagrams

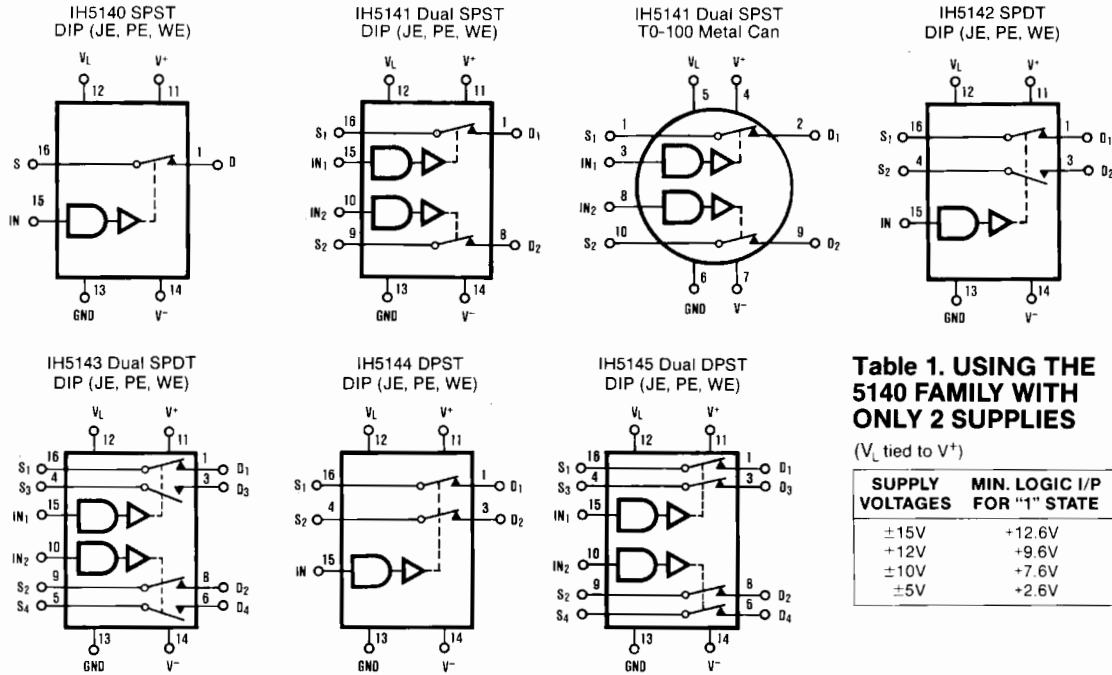

Table 1. USING THE 5140 FAMILY WITH ONLY 2 SUPPLIES

(V_L tied to V^+)

SUPPLY VOLTAGES	MIN. LOGIC I/P FOR "1" STATE
$\pm 15V$	+12.6V
+12V	+9.6V
$\pm 10V$	+7.6V
$\pm 5V$	+2.6V

Note: Switch states are for logic "1" input.

Ordering Information (continued)

PART	TEMP. RANGE	PACKAGE
DOUBLE POLE SINGLE THROW (DPST)		
IH5144C/D	0°C to +70°C	DICE
IH5144CJE	0°C to +70°C	16 Lead CERDIP
IH5144CPE	0°C to +70°C	16 Lead Plastic DIP
IH5144CWE	0°C to +70°C	16 Lead Wide SO
IH5144M/D	-55°C to +125°C	DICE
IH5144MJE	-55°C to +125°C	16 Lead CERDIP
DUAL DOUBLE POLE SINGLE THROW (DUAL DPST)		
IH5145C/D	0°C to +70°C	DICE
IH5145CJE	0°C to +70°C	16 Lead CERDIP
IH5145CPE	0°C to +70°C	16 Lead Plastic DIP
IH5145CWE	0°C to +70°C	16 Lead Wide SO
IH5145M/D	-55°C to +125°C	DICE
IH5145MJE	-55°C to +125°C	16 Lead CERDIP

For the IH5142 and IH5144 in 10 Lead Metal Can package contact factory. For all devices in Ceramic Flat Package contact factory.

Chip Topography

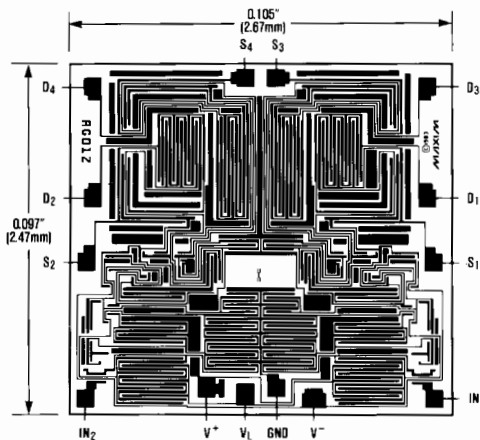

Maxim cannot assume responsibility for use of any circuitry other than circuitry entirely embodied in a Maxim product. No circuit patent licenses are implied. Maxim reserves the right to change the circuitry and specifications without notice at any time.

4 Maxim Integrated Products, 120 San Gabriel Drive, Sunnyvale, CA 94086 (408) 737-7600