



Schottky Barrier Diode MELF Surface Mount

Qualified per MIL-PRF-19500/444

Qualified Levels:
JAN, JANTX, and
JANTXV

DESCRIPTION

This Schottky barrier diode is metallurgically bonded and offers military grade qualifications for high-reliability applications. This small diode is hermetically sealed and bonded into a DO-213AA glass package. Also included in this datasheet are Microsemi's CDLL numbered variants of this series (military qualification grades not available for the CDLL prefix part numbers).

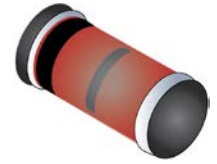

DO-213AA (MELF) Package

Important: For the latest information, visit our website <http://www.microsemi.com>.

FEATURES

- Surface mount equivalent of JEDEC registered 1N5711, 1N5712, 1N6857, and 1N6858 numbers.
- Hermetically sealed glass construction.
- Metallurgically bonded.
- Double plug construction.
- JAN, JANTX, JANTXV and commercial qualifications also available per MIL-PRF-19500/444 on "1N" numbers only.
(See [Part Nomenclature](#) for all available options).
- RoHS compliant versions available (commercial grade only).

Also available in:

 **UB package**
(3-pin surface mount)
[1N5711UB, 1N5712UB](#)
(B, CC, CA)

 **DO-35 package**
(axial-leaded)
[1N5711-1, 1N5712-1,](#)
[1N6857-1, and 1N6858-1](#)

APPLICATIONS / BENEFITS

- Low reverse leakage characteristics.
- Small size for high density mounting using the surface mount method (see package illustration).
- ESD sensitive to Class 1.

MAXIMUM RATINGS @ 25 °C unless otherwise stated

Parameters/Test Conditions	Symbol	Value	Unit
Junction and Storage Temperature	T_J and T_{STG}	-65 to +150	°C
Thermal Resistance, Junction-to-End Cap	$R_{\theta JEC}$	250	°C/W
Average Rectified Output Current:	I_O	5711 & 6263 types ⁽¹⁾	mA
		2810, 5712 & 6858 types ⁽²⁾	
		6857 types ⁽³⁾	
Solder Temperature @ 10 s		260	°C

- NOTES:**
1. At T_{EC} and $T_{SP} = +140$ °C, derate I_O to 0 at +150 °C.
 2. At T_{EC} and $T_{SP} = +130$ °C, derate I_O to 0 at +150 °C.
 3. At T_{EC} and $T_{SP} = +110$ °C, derate I_O to 0 at +150 °C.

MSC – Lawrence

6 Lake Street,
Lawrence, MA 01841
Tel: 1-800-446-1158 or
(978) 620-2600
Fax: (978) 689-0803

MSC – Ireland

Gort Road Business Park,
Ennis, Co. Clare, Ireland
Tel: +353 (0) 65 6840044
Fax: +353 (0) 65 6822298

Website:

www.microsemi.com

MECHANICAL and PACKAGING

- CASE: Hermetically sealed glass DO-213AA MELF (SOD-80, LL34) case package.
- TERMINALS: Tin/lead plated or RoHS compliant matte-tin (on commercial grade only) over copper clad steel. Solderable per MIL-STD-750, method 2026.
- POLARITY: Cathode end is banded.
- MOUNTING: The axial coefficient of expansion (COE) of this device is approximately +6PPM/°C. The COE of the mounting surface system should be selected to provide a suitable match with this device.
- MARKING: Part number.
- TAPE & REEL option: Standard per EIA-296. Consult factory for quantities.
- WEIGHT: Approximately 0.2 grams.
- See [Package Dimensions](#) on last page.

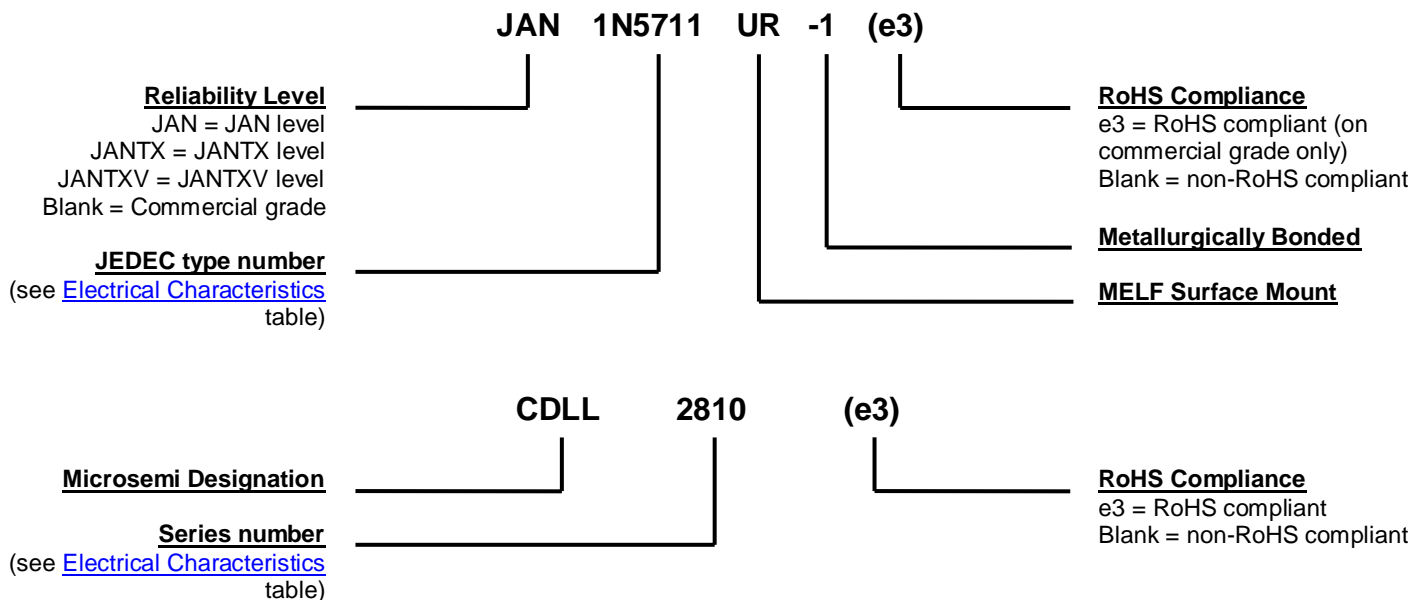
PART NOMENCLATURE

SYMBOLS & DEFINITIONS

Symbol	Definition
C	Capacitance: The capacitance in pF at a frequency of 1 MHz and specified voltage.
f	frequency
I _R	Reverse Current: The dc current flowing from the external circuit into the cathode terminal at the specified voltage V _R .
I _O	Average Rectified Output Current: The Output Current averaged over a full cycle with a 50 Hz or 60 Hz sine-wave input and a 180 degree conduction angle.
t _{rr}	Reverse Recovery Time: The time interval between the instant the current passes through zero when changing from the forward direction to the reverse direction and a specified decay point after a peak reverse current occurs.
V _(BR)	Breakdown Voltage: A voltage in the breakdown region.
V _F	Forward Voltage: A positive dc anode-cathode voltage the device will exhibit at a specified forward current.
V _R	Reverse Voltage: A positive dc cathode-anode voltage below the breakdown region.
V _{RWM}	Working Peak Reverse Voltage: The peak voltage excluding all transient voltages (ref JESD282-B). Also sometimes known historically as PIV.

ELECTRICAL CHARACTERISTICS @ $T_A = 25^\circ\text{C}$ unless otherwise noted

TYPE NUMBER	MINIMUM BREAKDOWN VOLTAGE	MAXIMUM FORWARD VOLTAGE	MAXIMUM FORWARD VOLTAGE	WORKING PEAK REVERSE VOLTAGE	MAXIMUM REVERSE LEAKAGE CURRENT		MAXIMUM CAPACITANCE @ $V_R = 0$ VOLTS $f = 1.0\text{ MHz}$
	$V_{(BR)} @ 10\ \mu\text{A}$	$V_F @ 1\ \text{mA}$	$V_F @ I_F$	V_{RWM}	$I_R @ V_R$		C_T
	Volts	Volts	V @ mA	V (pk)	nA	Volts	pF
1N5711UR-1	70	0.41	1.0 @ 15	50	200	50	2.0
1N5712UR-1	20	0.41	1.0 @ 35	16	150	16	2.0
1N6857UR-1	20	0.35	0.75 @ 35	16	150	16	4.5
1N6858UR-1	70	0.36	0.65 @ 15	50	200	50	4.5
CDLL2810	20	0.41	1.0 @ 35	50	100	15	2.0
CDLL5711	70	0.41	1.0 @ 15	50	200	50	2.0
CDLL5712	20	0.41	1.0 @ 35	16	150	16	2.0
CDLL6263	60	0.41	1.0 @ 15	16	200	50	2.2
CDLL6857	20	0.35	0.75 @ 35	16	150	16	4.5
CDLL6858	70	0.36	0.65 @ 15	50	200	50	4.5

NOTE:

1. Effective minority carrier lifetime (τ) is 100 pico seconds.

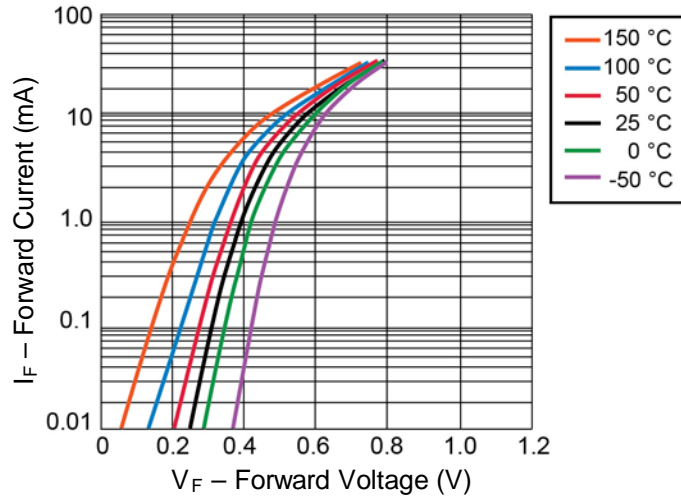
GRAPHS

FIGURE 1

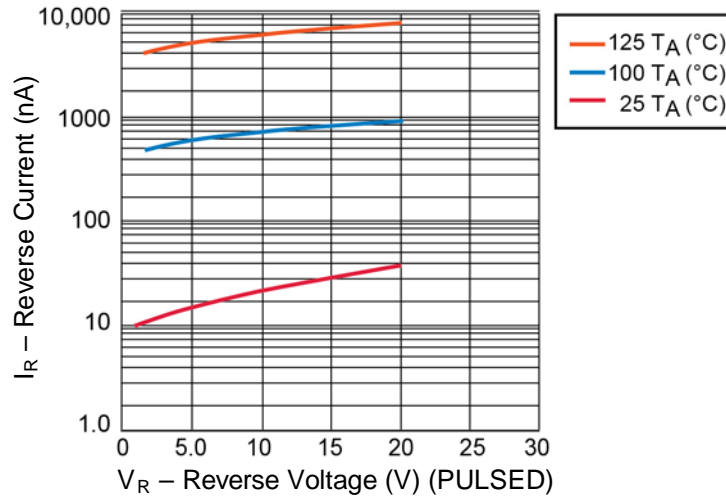
I-V Curve showing typical Forward Voltage Variation
Temperature for the 1N5712UR-1, CDLL5712 and CDLL2810 Schottky Diodes

FIGURE 2

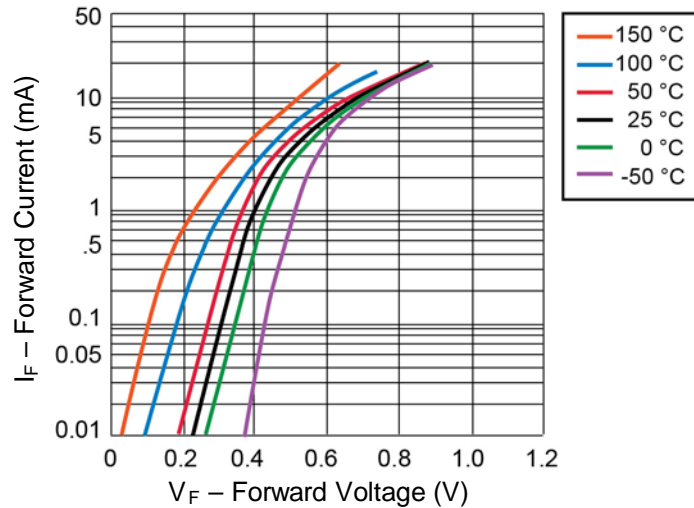
1N5712UR-1, CDLL5712 and CDLL2810 Typical variation of Reverse
Current (I_R) vs Reverse Voltage (V_R) at Various Temperatures

GRAPHS

FIGURE 3

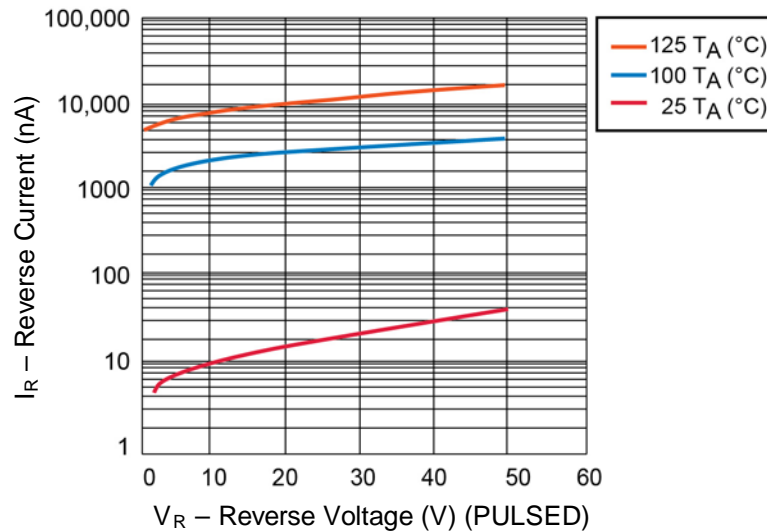
I – V curve showing typical Forward Voltage Variation
With Temperature Schottky Diode 1N5711UR-1

FIGURE 4

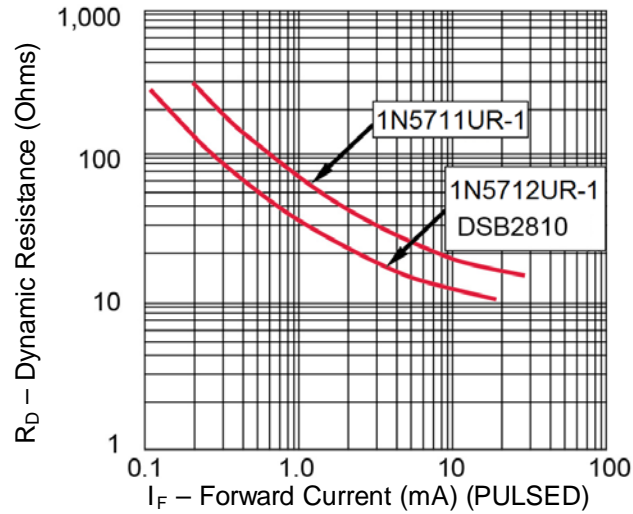
1N5711UR-1 Typical Variation of Reverse Current (I_R) vs Reverse Voltage (V_R)
at Various Temperatures

GRAPHS**FIGURE 5**

Typical Dynamic Resistance (R_D) vs Forward Current (I_F)

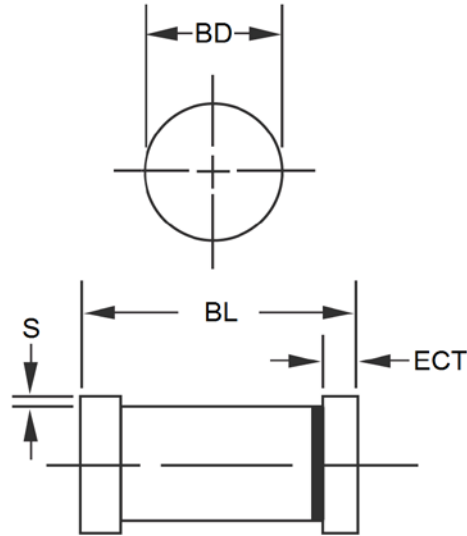
PACKAGE DIMENSIONS

DIM	INCH		MILLIMETERS	
	MIN	MAX	MIN	MAX
BD	0.063	0.067	1.60	1.70
BL	0.130	0.146	3.30	3.71
ECT	0.016	0.022	0.41	0.56
S	0.001 min		0.03 min	

NOTES:

1. Dimensions are in inches. Millimeters are given for information only.
2. Dimensions are pre-solder dip.
3. Referencing to dimension S, minimum clearance of glass body to mounting surface on all orientations.
4. In accordance with ASME Y14.5M, diameters are equivalent to Φ x symbology.

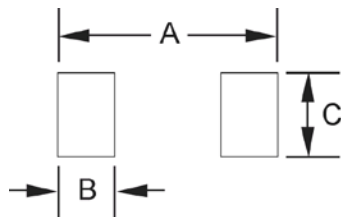
PAD LAYOUT

	INCH	mm
A	0.200	5.08
B	0.055	1.40
C	0.080	2.03