

## Peak Emission Wavelength: 740nm

The MTE1074N1-R is a red T 1 3/4, 5mm water clear emitter designed for applications requiring high power output and high reliability in a narrow angle package.

### FEATURES

- > High Reliability
- > Narrow Beam Angle
- > High Output Power

### APPLICATIONS

- > Optical Sensors
- > Optical Switches
- > Medical Application

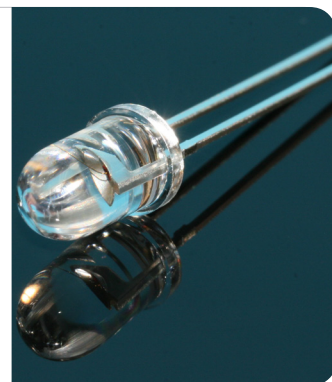

## Absolute Maximum Ratings (Ta=25°C)



ITEMS	SYMBOL	RATINGS	UNIT
Forward Current (DC)	IF	50	mA
Forward Current (Pulse)*1	IFP	0.5	A
Reverse Voltage	VR	5	V
Power Dissipation	PD	120	mW
Operating Temperature Range	Topr	-20 ~ +80	°C
Storage Temperature Range	Tstg	-30 ~ +100	°C
Junction Temperature	Tj	100	°C
Lead Soldering Temperature*2	Tls	260	°C

\*1: Tw=10μsec, T=10msec; \*2: Time 3 Sec max, Position: Up to 2mm from the body.

## Electrical & Optical Characteristics (Ta = 25°C)

ITEMS	SYMBOL	CONDITIONS	MIN	TYP	MAX	UNIT
Power Output	PO	IF=20mA	--	4.0	--	mW
Forward Voltage	VF	IF=20mA	--	1.8	2.3	V
Reverse Current	IR	VR=5V	--	--	100	μA
Peak Emission Wavelength	λp	IF=20mA	--	740	--	nm
Spectral Line Half Width	Δλ	IF=20mA	--	30	--	nm
Half Intensity Beam Angle	Θ	IF=20mA	--	±12	--	deg
Rise Time	Tr	IFP=20mA	--	--	--	nS
Fall Time	Tf	IFP=20mA	--	--	--	nS
Junction Capacitance	Cj	1MHz, V=0V	--	35	--	pF
Temperature Coefficient of PO	P/T	IF=10mA	--	-0.6	--	%/°C
Temperature Coefficient of VF	V/T	IF=10mA	--	-1.9	--	mV/°C

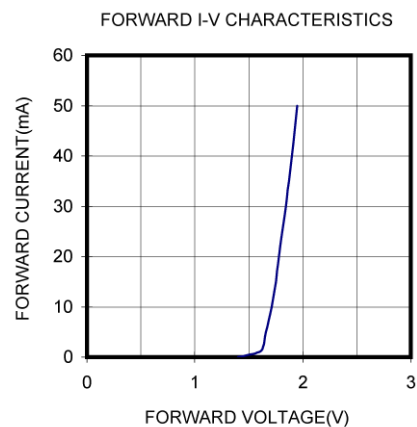
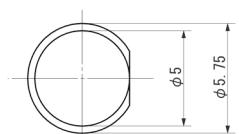
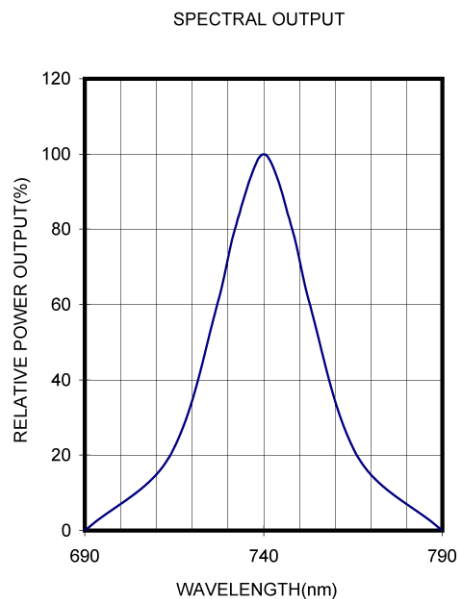
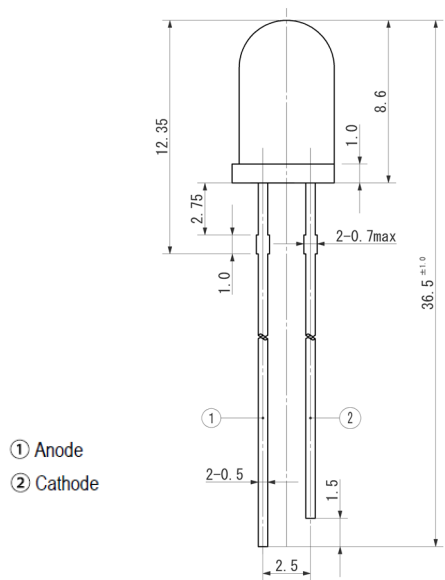

Unit: mm, Tolerance:  $\pm 0.2$

2012-05-17

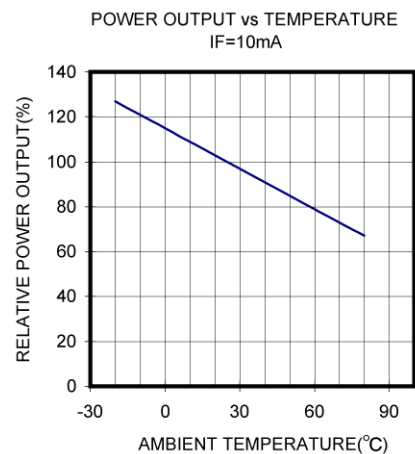
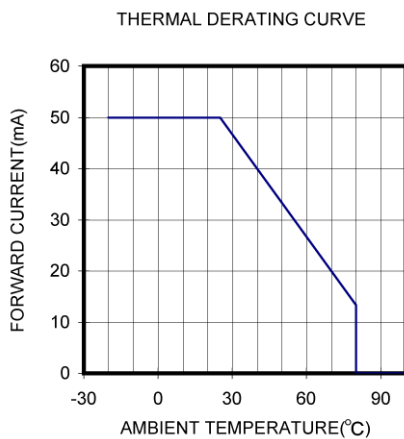
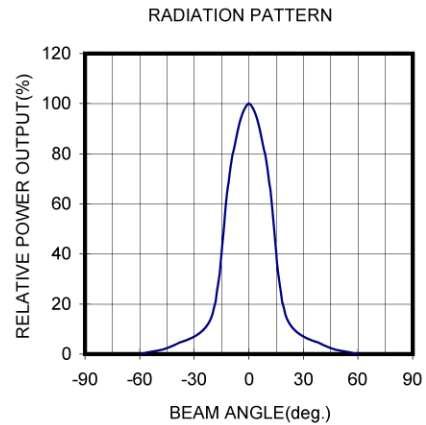
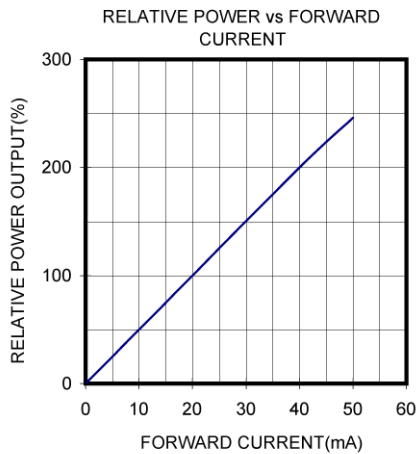

The information contained herein is subject to change without notice.

2012-05-17

