

MODEL:

# PDU3XVSRHWA

## 3-Phase Switched Rackmount PDU



380V - 415V  
3-Phase Input



Hardwire



220V - 240V  
Single-Phase  
Output



24 Outlets



28.8kW Load  
Capacity



Multimode  
Load Meter

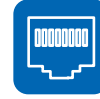

Network  
Interface



0U  
Rackmount



Toolless  
Mounting  
Buttons

- A** Multimode Load Meter
- B** C13 and C19 Outlets with Multi-Function LEDs
- C** 20A Single Pole Hydraulic Magnetic Circuit Breakers
- D** C13 and C19 Plug Inserts
- E** Removable Mounting Brackets
- F** Toolless Mounting Buttons with Removable 90° Rotation Brackets
- G** Hardwire Input
- H** Durable Metal Case
- I** Network Interface
- J** RJ45 Ethernet Jack
- K** Manual Configuration Port
- L** Environmental Monitoring Port
- M** Network Interface Reset Button

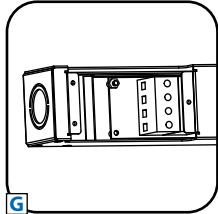

Hardwire Connection: Wire PDU to compatible utility, UPS, or generator power.

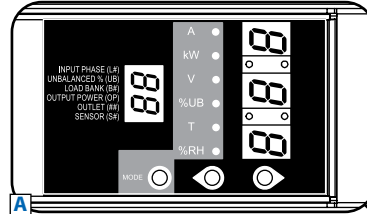

Multimode Load Meter: Display the load for any phase, bank or outlet, display temperature or humidity\*, display the IP address or rotate the display 180°.

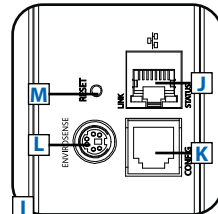
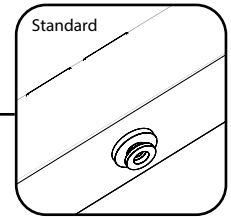
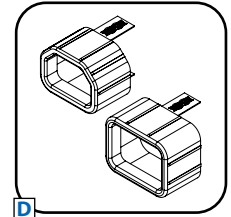
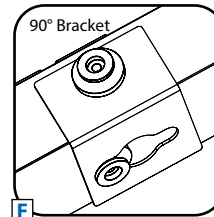
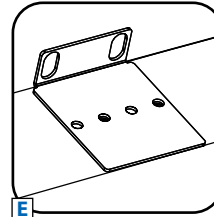
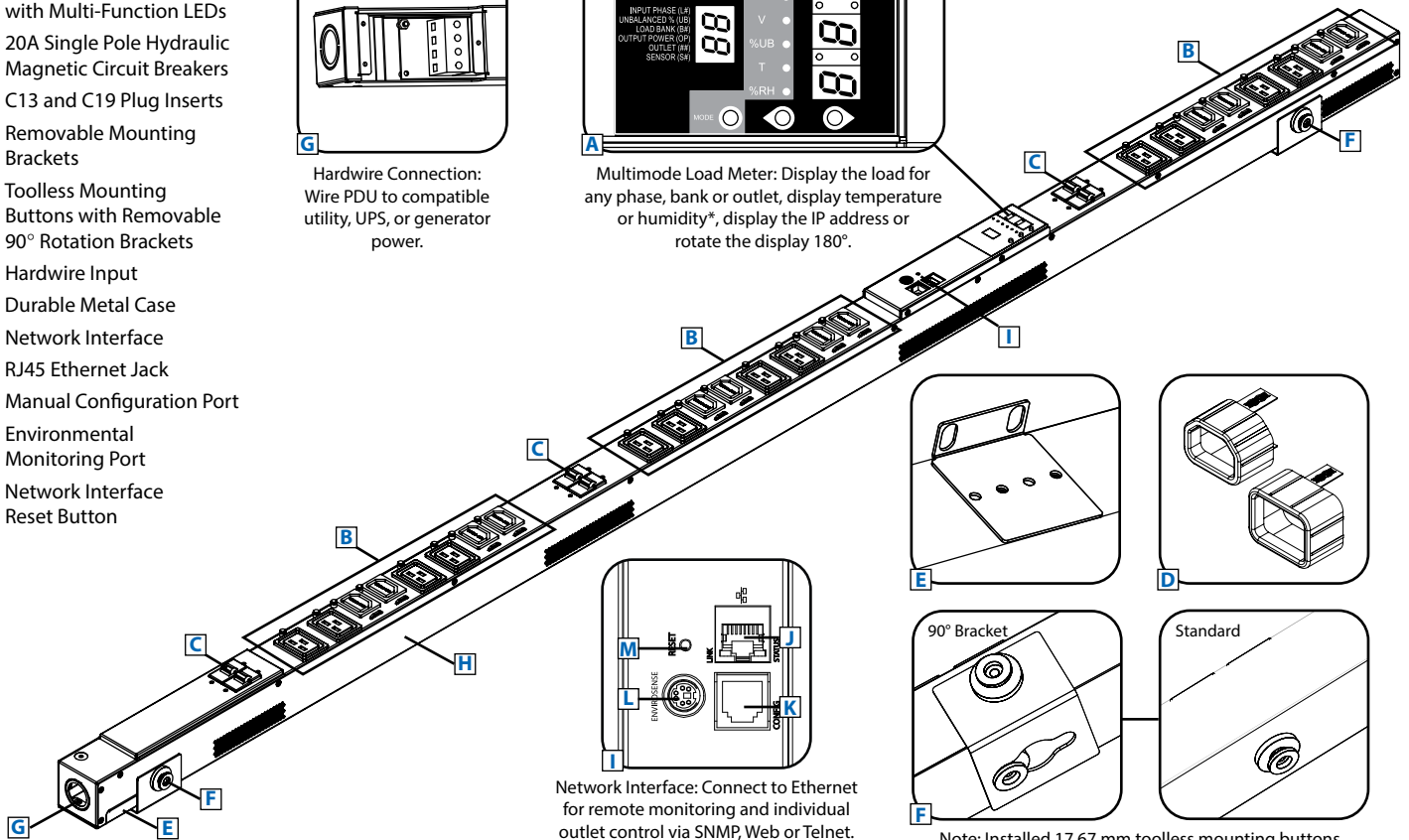

Network Interface: Connect to Ethernet for remote monitoring and individual outlet control via SNMP, Web or Telnet.

\*Add optional ENVIROSENSE accessory for temperature/humidity monitoring and dry contact interface.

Note: Installed 17.67 mm toolless mounting buttons can be replaced with included 14.17 mm buttons for additional compatibility.

### Specifications

Model	PDU3XVSRHWA
Voltage	380V - 415V (3-Phase Input/Single-Phase Output)
Frequency	50 / 60 Hz
Load Capacity	28.8kW
Input	Hardwire
Outlets	24 (12 C13 / 12 C19)
Primary Mounting Option	0U (Vertical) Rackmount
Unit Weight & Dimensions	13 lbs / 70 x 2.17 x 2.52 (HxWxD in inches) 5.9 kg / 177.8 x 5.51 x 6.4 (HxWxD in cm) <i>See next page for detailed unit measurements.</i>
Standards	Tested to UL 60950-1 (US & Canada), EN 60950-1, NOM (Mexico), FCC Class A, CE Class A

Tripp Lite has a policy of continuous improvement. Specifications are subject to change without notice.



- Distributes power to 24 outlets (4 C13 & 4 C19 per phase)
- Remote monitoring and control via SNMP, Web or Telnet
- Displays load for *each bank, phase, and outlet* in real time
- Perfect for rackmount server, network and telecom applications

**SEE NEXT PAGE FOR DETAILED UNIT MEASUREMENTS**



1111 W. 35th Street  
Chicago, IL 60609 USA  
773.869.1234  
www.tripplite.com

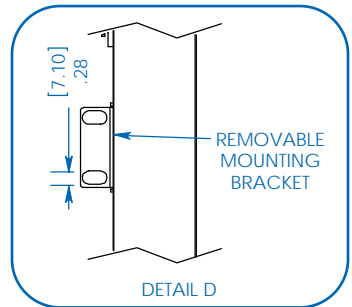
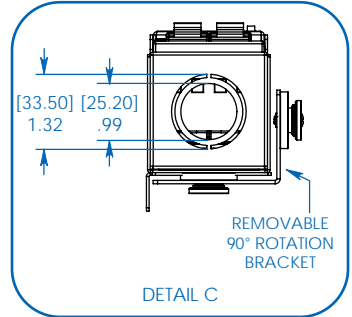
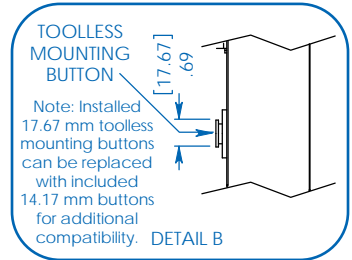
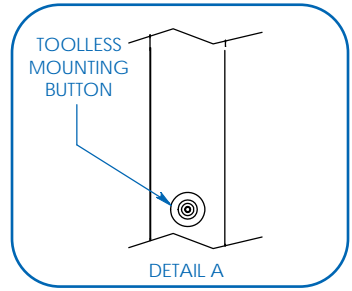
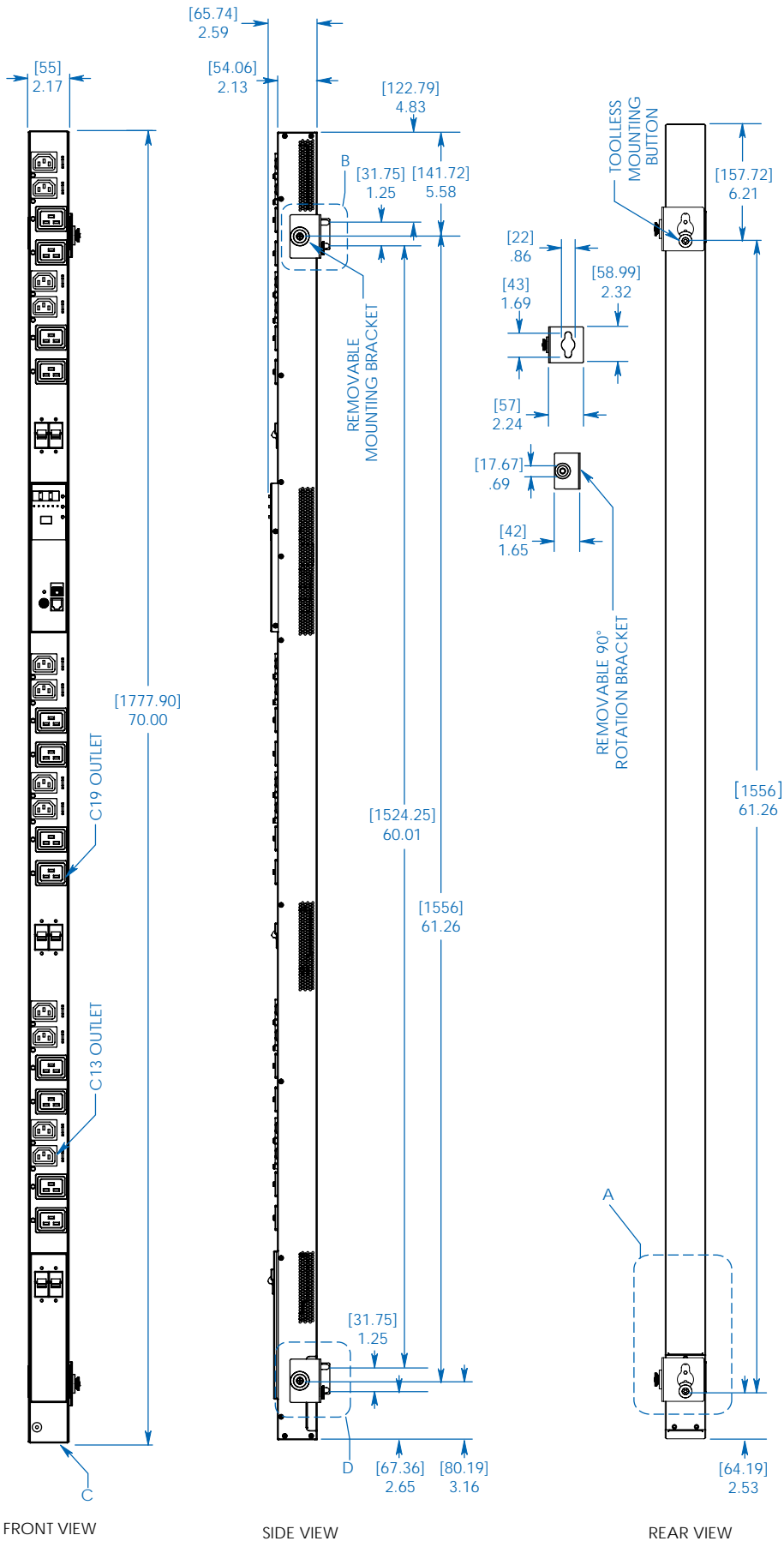

Dimensions: [mm] INCHES

Tripp Lite has a policy of continuous improvement. Specifications are subject to change without notice.

MODEL:  
**PDU3XVSRHWA**



1111 W. 35th Street  
Chicago, IL 60609 USA  
773.869.1234

[www.tripplite.com](http://www.tripplite.com)